

HUGO GERNSBACK, *Editor*

RADIO CRAFT

In this issue—

FM Carrier Stabilization

High-Fidelity Amplifier

Clamping Circuits

THE ANTENNALYZER

SEE PAGE 536



MAY

1946

25¢

CANADA 30¢

RADIO-ELECTRONICS IN ALL ITS PHASES

NEW

... and Individually Marked



Resistance value and wattage are marked on every unit for quick identification.

Enlarged view

Meet Joint Army-Navy Specification JAN-R-11
AVAILABLE FROM STOCK IN STANDARD
RMA 10% TOLERANCE VALUES

TYPE	SIZE		RESISTANCE RANGE	MAXIMUM VOLTS	LIST PRICE
	LENGTH	DIAM.			
1/2 Watt	3/8"	5/64"	10 Ohms to 22 Meg.	500	13c
1 Watt	9/16"	7/32"	10 Ohms to 22 Meg.	1000	17c
2 Watt	1 1/16"	5/16"	10 Ohms to 22 Meg.	3500	25c



Send Now for
BULLETIN No. 127

Gives complete data and list of RMA values. Includes dimensional drawings and handy color code. Write for it today!

OHMITE

Little Devil

INSULATED COMPOSITION RESISTORS

1/2 Watt • 1 Watt • 2 Watt • ±10% Tolerance

NOW . . . OHMITE makes available to you three *Little Devils* of exceptional ruggedness and stability!

Millions of these tiny molded fixed composition resistors have been used in critical war equipment and in the nation's foremost laboratories. They meet Joint Army-Navy Specification JAN-R-11, including salt water immersion cycling and high humidity tests. They can be used at their full wattage ratings at 70°C (158°F) ambient temperature. They dissipate heat rapidly—have low noise level and low voltage coefficient.

Ratings for maximum continuous RMS voltage drop are high: 500 volts for the 1/2 watt unit—1000 volts for the 1 watt unit—3500 volts for the 2 watt unit. Units have high insulation breakdown voltage.

Little Devils are completely sealed and insulated by their molded plastic construction. Leads are soft copper wire, hardened immediately adjacent to resistor body—strongly anchored—and hot solder coated.

Light, compact, easy to install. All units color coded. Resistance value and wattage are marked on every unit for quick identification. Available from stock in Standard RMA values from 10 ohms to 22 megohms.

Little Devils are ready for any job . . . anywhere. And they're low in cost. Order them now!

AVAILABLE ONLY THROUGH OHMITE DISTRIBUTORS

OHMITE MANUFACTURING COMPANY

4896 FLOURNOY STREET, CHICAGO 44, U.S.A.

Be Right with

OHMITE

RHEOSTATS • RESISTORS • TAP SWITCHES • CHOKES • ATTENUATORS

A FREE LESSON SHOWED BILL HOW HE COULD MAKE GOOD PAY IN RADIO!



I will send you a Lesson on Radio Servicing Tips **FREE**

TO SHOW HOW PRACTICAL IT IS TO TRAIN AT HOME FOR

GOOD JOBS IN RADIO

I want to give every man who's interested in Radio, either professionally or as a hobby, a copy of my Lesson, "Radio Receiver Troubles--Their Cause and Remedy"--absolutely **FREE!** It's a valuable lesson. Study it--keep it--use it--without obligation! And with it I'll send my 64-page, illustrated book, "Win Rich Rewards in Radio," **FREE!** It describes many fascinating jobs in Radio, tells how N.R.I. trains you at home in spare time, how you get **practical experience** with **SIX BIG KITS OF RADIO PARTS** I send.

This "Sample" Lesson will show you why the easy-to-grasp lessons of the N.R.I. Course have paved the way to good pay for hundreds of other men. I will send it to you without obligation... **MAIL THE COUPON!**

Future for Trained Men is Bright in Radio, Television, Electronics

The Radio Repair business is booming **NOW!** There is good money fixing Radios in your spare time or own full time business. And trained Radio Technicians also find good pay opportunities in Police, Aviation and Marine Radio, in Broadcasting, Radio Manufacturing, Public Address work, etc. Think of the boom coming now that new Radios can be made! And think of even greater opportunities when Television and Electronics are available to the public! Get into Radio **NOW!**

Many Beginners Soon Make \$5, \$10 a Week **EXTRA** in Spare Time

The day you enroll I start sending **EXTRA MONEY JOB SHEETS** to help you

Our 32nd Year of Training Men for Success in Radio

My Radio Course Includes Training in **TELEVISION • ELECTRONICS • FREQUENCY MODULATION**



make **EXTRA** money fixing Radios in spare time while learning. You **LEARN** Radio Principles from my easy-to-grasp Lessons--**PRACTICE** what you learn by building real Radio Circuits with the six kits of Radio parts I send--**USE** your knowledge to make **EXTRA** money while getting ready for a good full time Radio job.

Find Out What N.R.I. Can Do for YOU

MAIL COUPON for Sample Lesson and **FREE** 64-page book. It's packed with facts about opportunities for you. Read the details about my Course. Read letters from men I trained, telling what they are doing, earning. Just **MAIL COUPON** in an envelope or paste it on a penny postal.--J. E. SMITH, President, Dept. 6EX, National Radio Institute, Pioneer Home Study Radio School, Washington 9, D. C.

You Build These and Other Radio Circuits with 6 BIG KITS OF PARTS I SEND YOU!

By the time you've conducted 60 sets of Experiments with Radio Parts I supply, made hundreds of measurements and adjustments, you'll have valuable **PRACTICAL** Radio experience for a good full or part-time Radio job!



SUPERHETERODYNE CIRCUIT (right) Preselector, oscillator-mixer-first detector, i.f. stage, diode detector--a.v.c. stage, audio stage. Bring in local and distant stations on this circuit you build yourself!

MEASURING INSTRUMENT (above) you build early in Course. Use it in practical Radio work to make **EXTRA** money. Vacuum tube multimeter, measures A.C., D.C., and R.F. volts, D.C. currents, resistance, receiver output.



A. M. SIGNAL-GENERATOR (left) build it yourself! Provides amplitude-modulated signals for test and experimental purposes. Gives valuable practice!



GET BOTH 64 PAGE BOOK **FREE**

MR. J. E. SMITH, President, Dept. 6EX NATIONAL RADIO INSTITUTE, Washington 9, D. C.

Mail me **FREE**, without obligation, Sample Lesson and 64-page book about how to win success in Radio and Television--Electronics. (No salesman will call. Please write plainly.)

Age.....

Name

Address

City Zone..... State..... 14X1

If you are a war veteran, check here

Not too many... not too few!

Also at
your IRC
Distributor's

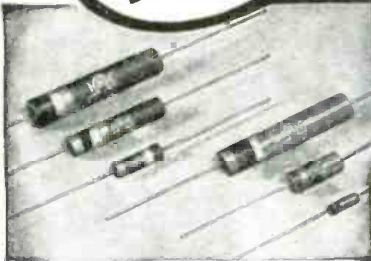

TYPE BT INSULATED METALLIZED and
TYPE BW INSULATED WIRE WOUNDS
...the perfect combination.

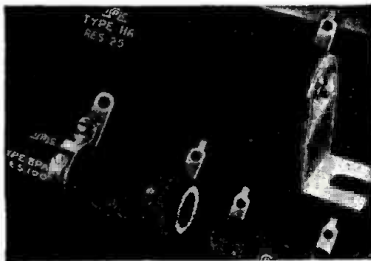

POWER WIRE WOUNDS... rugged,
moisture proof, completely dependable.

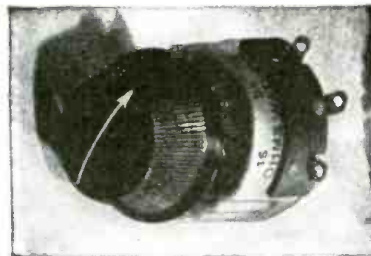

POWER RHEOSTATS (above), Pre-
cisions, Wire Wound Controls, Bleeders,
Non-inductive Wire Wounds, etc. (be-
low)—for many service needs.

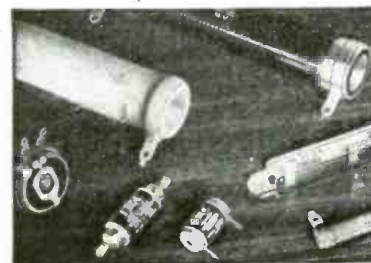

The IRC *Century Line* is a commonsense selection of the controls you need for complete service

The controls in the *IRC Century Line* were carefully selected after exhaustive study of IRC sales records and of the requirements of receivers and equipment now in use.

These studies showed that the number of types previously listed could be reduced considerably, yet give adequate coverage. But it also proved that reducing the number of available types to anything *less* than the 100 now comprising the *Century Line*, would make the service engineer's replacement problem extremely difficult.

On that basis, we established the *Century Line*—not too many, not too few—but just right to give you properly designed, easily installed con-

trols for the widest variety of replacement needs.

Best of all, it's *not* necessary for you to actually stock all the 100 *Century Line* types! We recommend you maintain a minimum stock of at least the 18 Type D Controls listed on page 6 of IRC Catalog #50—they'll handle 87% of your replacements—and you can depend upon your IRC distributor for other types, as required.

And don't forget, *only IRC controls* give you such quiet, smooth, dependable performance!... because they're the only controls with the famous IRC Metallized Element, the Five Finger Contactor, and the Silent Spiral Connector!

YOUR IRC DISTRIBUTOR is the man to know when you need any type of resistor... there is an IRC resistance unit for almost every servicing requirement. Ask him for your copy of IRC Service Catalog #50.

FOR BETTER-THAN-STANDARD QUALITY... *Standardize on*

INTERNATIONAL RESISTANCE CO.

Dept. 25-E 401 N. BROAD ST., PHILA. 8, PA.

Canadian Licensee: International Resistance Co., Ltd., Toronto



MAKERS OF MORE TYPES OF RESISTANCE UNITS, IN MORE SHAPES, FOR MORE APPLICATIONS, THAN ANY OTHER MANUFACTURER IN THE WORLD.

RADIO-CRAFT for MAY, 1946

The New Model CA-11

SIGNAL TRACER

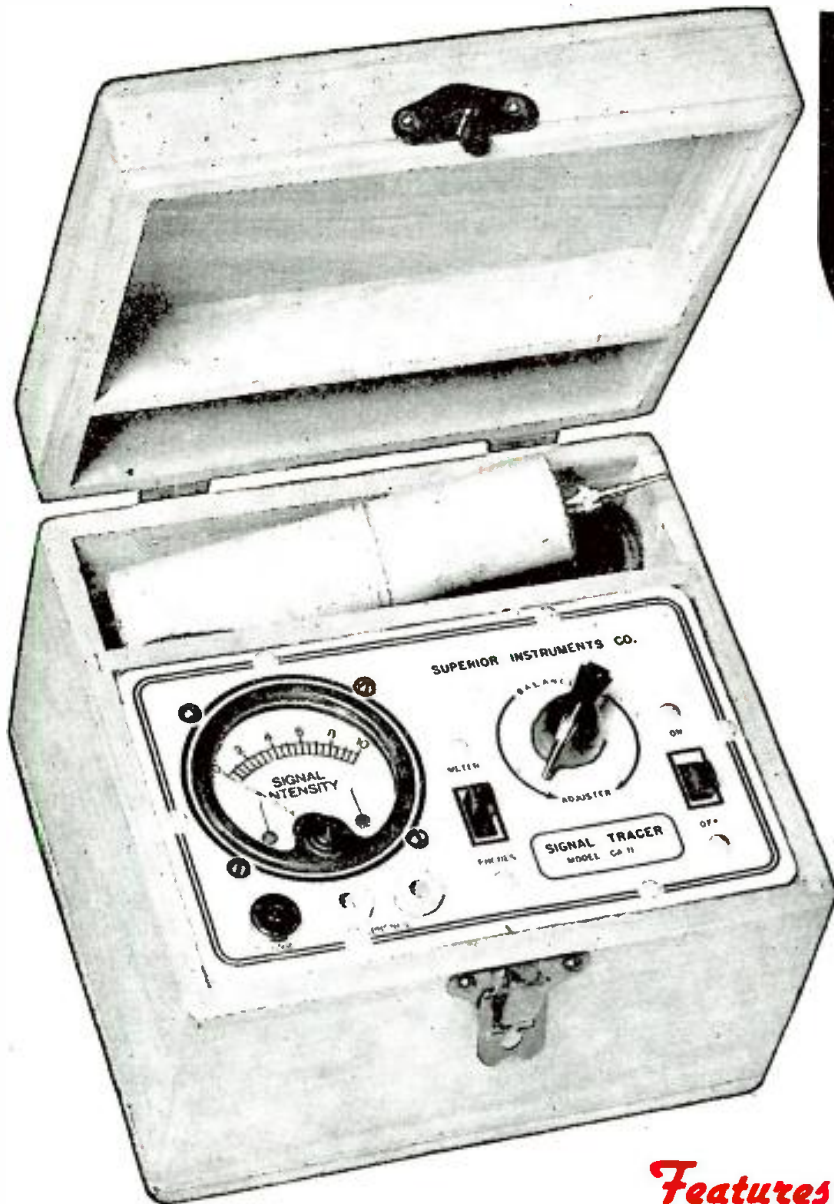

Simple to operate
... because it has only
ONE connecting cable—
NO tuning controls!

Introduced in 1939-1940 Signal Tracing, the "short-cut" method of Radio Servicing quickly became established as the accepted method of localizing the cause of trouble in defective radio receivers. Most of the pre-war testers (including ours) were bulky requiring a number of connections before the unit was "set for operation" and included a tuned amplifier which had to be "retuned" to compensate for signal shift. The new model CA-11 affords all the advantages offered by the pre-war models and only weighs 5 lbs. and measures 5" x 6" x 7". Always ready for immediate use without the necessity of connecting cables, this amazingly versatile unit has **NO TUNING CONTROLS**.

Essentially "Signal Tracing" means following the signal in a radio receiver and using the signal itself as a basis of measurement and as a means of locating the cause of trouble. In the CA-11 the Detector Probe is used to follow the signal from the antenna to the speaker—with relative signal intensity readings available on the scale of the meter which is calibrated to permit constant comparison of signal intensity as the probe is moved to follow the signal through the various stages.

Features

- ★ **SIMPLE TO OPERATE**—only 1 connecting cable—**NO TUNING CONTROLS**.
- ★ **HIGHLY SENSITIVE**—uses an improved Vacuum Tube Voltmeter circuit. Tube and resistor-capacity network are built into the Detector Probe.
- ★ **COMPLETELY PORTABLE**—weighs 5 lbs. and measures 5"x6"x7".
- ★ Comparative Signal Intensity readings are indicated directly on the meter as the Detector Probe is moved to follow the Signal from Antenna to Speaker.
- ★ Provision is made for insertion of phones.

Please place your order with your regular radio parts jobber. If your local jobber cannot supply you kindly write for a list of jobbers in your state who do distribute our instruments, or send your order directly to us.

The Model CA-11 comes housed in a beautiful hand-rubbed wooden cabinet. Complete with Probe, test leads and instructions. NET PRICE.....

\$18⁷⁵
18⁷⁵



SUPERIOR INSTRUMENTS CO.

DEPT. R 227 FULTON STREET NEW YORK 7, N. Y.

RADIO-CRAFT for MAY, 1946

BUSINESS GETTERS



With direct mail, you can multiply the prospects who come to your door—bring in new customers to keep your business and your profits steadily growing. Raytheon Bonded Electronic Technicians have a big story to tell—and have effective self-mailers to tell that story to the public. These direct mail pieces are only a part of the broad program of *selling helps* made available *only* to Raytheon Bonded Electronic Technicians. Bonded service means better customer relations. For full details to qualify, see your Raytheon distributor today.

ANOTHER REASON WHY IT PAYS TO QUALIFY AS A RAYTHEON BONDED ELECTRONIC TECHNICIAN



Excellence in Electronics



RADIO RECEIVING TUBE DIVISION
NEWTON, MASS. • NEW YORK • CHICAGO

LET ME TRAIN YOU

for RADIO ELECTRONICS & TELEVISION

I'll Supply a **FULL RADIO SET**

for SIMPLIFIED INSTRUCTION — PRACTICE & TESTING

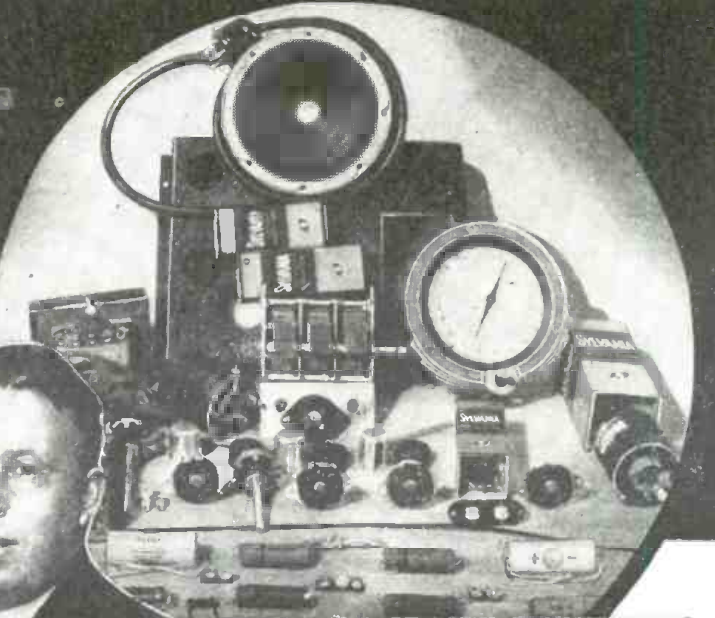

Beginners Learn FAST
START NOW! Big Developments
 Ahead in F. M., Radar, Television

MAKE GOOD MONEY IN
a Business of Your Own
...or a Good Radio Job.



Mind training through hand practice with a FULL RADIO SET . . . that's the interesting way I'll teach you Radio. And it's the latest, most practical method of all to fix in your head permanently the essential money-making Radio knowledge. The offer I make you here is the opportunity of a lifetime. I'll prepare you easily and quickly for a wonderful future in the swiftly expanding field of Radio-Electronics INCLUDING Radio, Television, Frequency Modulation and Industrial Electronics. Be wise! NOW'S the time to start. Opportunities ahead are tremendous! No previous experience is necessary. The Sprayberry Course starts right at the beginning of Radio. You can't get lost. It gets the various subjects across in such a clear, simple way that you understand and remember. And, you can master my entire course in your spare time . . . right at home.

You Do Practical Experiments

There's only one right way to learn Radio Electronics. You must get it through simplified lesson study combined with actual "shop" practice under the personal guidance of a qualified Radio Teacher. It's exactly this way that Sprayberry trains you . . . supplying real Radio parts for learn-by-doing experience right at home. Thus, you learn faster, your understanding is clear-cut.

I'll Show You a New, Fast Way to Test Radio Sets Without Mfg. Equipment

The very same Radio Parts I supply with your Course for gaining pre-experience in Radio Repair work may be adapted through an exclusive Sprayberry wiring procedure to serve for complete, fast, accurate Radio Receiver trouble-

shooting. Thus, under Sprayberry methods, you do not have one cent of outlay for manufactured Test Equipment.

Succeed As a Radio-Electronician

My training will give you the broad, fundamental principles so necessary as a background, no matter which branch of Radio you wish to specialize in. I make it easy for you to learn Radio Set Repair and Installation Work. I teach you how to install and repair Electronic Equipment. In fact, you'll be a fully qualified RADIO-ELECTRONICIAN, equipped with the skill and knowledge to perform efficiently and to make a wonderful success of yourself.

Read What Graduate Says
"One Job Nets About \$26.00"

"Since last week I fixed 7 radios, all good-paying jobs, and right now I am working on an amplifier system. This job alone will net me about \$26.00. As long as my work keeps coming in this way, I have only one word to say and that is, 'Thanks' to my Sprayberry training, and I am not afraid to boast about it."—ADRIEN BENJAMIN, North Grosvenordale, Conn.

DON'T PUT IT OFF!

Get the facts about my training—now! Take the first important step toward the money-making future of your dreams. All features are fully explained in my big, illustrated FREE Catalog which comes to you along with another valuable FREE book you'll be glad to own.

FREE BOOKS
"How To Read Radio Diagrams and Symbols"

Here's a valuable and wonderfully complete new book which explains in simple, non-technical English how to read and understand any Radio Set Diagram. Provides the quick key to analyzing any Radio circuit. Includes translations of all Radio symbols. This instructive volume is yours for the asking—without obligation. Send for it AT ONCE, and along with it I will send you another big free book, describing in complete, interesting detail my Radio-Electronic training.

RUSH
COUPON
for BOTH



SPRAYBERRY ACADEMY OF RADIO
 F. L. Sprayberry, President
 Room 2056, Pueblo, Colorado

Please rush my FREE copies of "How to MAKE MONEY in RADIO ELECTRONICS and TELEVISION," and "How to READ RADIO DIAGRAMS and SYMBOLS."

Name Age.....
 Address
 City State.....
 (Mail in envelope or paste on penny postcard)

MAIL COUPON AT ONCE!

RADIO CRAFT

AND POPULAR ELECTRONICS

Incorporating
SHORT WAVE CRAFT TELEVISION NEWS
RADIO & TELEVISION



HUGO GERNSBACK, *Editor-in-Chief*
FRED SHUNAMAN, *Managing Editor*
MAJ. M. H. GERNSBACK, *Cons't'g Ed.*
R. F. SCOTT, *Technical Editor*
I. QUEEN, *Editorial Associate*
ELMER FULLER, *Shortwave Editor*
A. PASCALE, *Production Manager*
G. ALIQUO, *Circulation Manager*
JOHN J. LAMSON, *Advertising Director*
ALFRED STERN, *Promotion Manager*

IN THE NEXT ISSUE

Modern Television Course
High-Fidelity BC Tuner
A 5-Tube Superheterodyne
Hum Level Reduction

Published by Radcraft Publications, Inc.
Publication Office: 29 Worthington Street, Springfield 3, Mass.
Editorial and Advertising Offices: 25 West Broadway, Tel. RE 2-9690, New York 7, N. Y.
Chicago Advertising Office: Radio-Craft, 308 W. Washington Street, Suite 1413, Chicago 6, Ill. Tel. Randolph 7363.
Cleveland Advertising Office: 405 Erie Bldg., Cleveland, Ohio. Burdette Phillips, Manager. Tel. Main 9645.
Los Angeles Advertising Office: 606 South Hill Street, Los Angeles 14, Calif. Ralph W. Harker, Manager. Tel. Tucker 1793.
San Francisco Advertising Office: 582 Market St., San Francisco 4, Calif. Ralph W. Harker, Manager. Tel. Garfield 2481.
RADIO-CRAFT is published monthly on the 25th of the month preceding that of date. Subscription rates: United States and possessions, Mexico, Central and South American countries, \$2.50 a year, \$4.00 for two years, \$6.00 for three years. Canada, \$3.00 a year, \$5.00 for two years, \$7.50 for three years. All other foreign countries, \$3.25 a year, \$5.50 for two years, \$8.25 for three years. Special rates for members of the Armed Forces in U. S., or those addressed by A.P.O. or F.P.O. mail, \$2.00. Entered at the post office at Springfield as second-class matter under the Act of March 3, 1879. All communications about subscriptions should be addressed to: Circulation Manager, Radio-Craft, 29 Worthington St., Springfield 3, Mass.

Notice of CHANGE of ADDRESS should reach us at least one month in advance. When ordering a change, please furnish an address stencil impression from a recent wrapper if you can. Address changes cannot be made without the old address as well as the new.

Foreign Agents

London—Atlas Publishing and Distributing Co., Ltd., 18 Bride Lane, Fleet St., London, E.C. 4.

Melbourne—McGill's Agency, 179 Elizabeth St., Australia.

Text and illustrations of this magazine are copyright and must not be reproduced without permission of the copyright owners.
Copyright, 1946, Radcraft Publications, Inc.

RADCRAFT PUBLICATIONS, INC.:
Hugo Gernsback, *President*
Maj. M. Harvey Gernsback, *Vice Pres.*
G. Aliquo, *Secretary*

Contents

May, 1946

Volume XVIII No. 8

Editorial: Radio Industry Unfair?.....	by Hugo Gernsback	529
Radio-Electronics Monthly Review.....		530, 531
Radio Thirty-Five Years Ago.....		557

ELECTRONICS

Demonstration Devices.....	by W. K. Allan	532
The RCA Antennalyzer (Cover Feature).....		536
FM Carrier Stabilization.....	by I. Queen	537
Clamping Circuits.....	by Jordan McQuay	541

SERVICING

Visual Radio Alignment.....	by Eugene J. Thompson	540
Logic—A Repair Tool.....	by Edward J. Bukstein	543
Radio Data Sheet No. 335: RCA Victor Models 54B1, 54B1-N, 54B2, 54B3.....		547

CONSTRUCTION

A U.H.F. Ham Transceiver.....	by I. Queen	545
Plug-Ugly Eliminator.....	by Maurice A. Kay	580

TEST INSTRUMENTS

Multipurpose Tester.....	by Bob White	534
A Versatile VTVM.....	by Edward W. Harding	535

SOUND

Superamp With Tuner.....	by Cyril G. Brennan	539
--------------------------	---------------------	-----

DEPARTMENTS

World-Wide Station List.....	Edited by Elmer R. Fuller	544
Radio-Electronic Circuits.....		546
New Radio-Electronic Devices.....		548
Try This One.....		552
Technotes.....		554
Why Not?.....		557
The Question Box.....		558
New Radio Patents.....	by I. Queen	562
Available Radio-Electronic Literature.....		582
Communications.....		583
Book Reviews.....		587

Biographical Portrait Drawings by Constance Joan Neer

ON THE COVER

Our cover this month illustrates one of radio's uses of electronic apparatus in its own industry. The RCA Antennalyzer speeds up design of multi-unit antenna arrays, performing intricate calculations and throwing the result in graphic form on the screen of the cathode-ray oscilloscope at left.

Chromatone by Alex Schomburg from RCA photo



New! Spectacular! Complete!

CONCORD RADIO CATALOG



RADIO SETS

AMPLIFIERS

RADIO PARTS

ELECTRONIC EQUIPMENT

Mail
Coupon for
FREE
Copy!

WE HAVE WHAT YOU WANT!

The new Concord Catalog displays the most comprehensive stock in years! All well-known, standard lines are fully represented. Equipment—accessories—parts for all radio and electronic use ...for building, repair, maintenance...for engineer, amateur, serviceman, soundman, retailer ... complete lines of tubes, instruments, tools, speakers, condensers, resistors, relays, etc... PLUS a radio set department offering latest postwar models... PLUS the exciting line of MULTIAMP Add-A-Unit Amplifiers offering many innovations in public address units obtainable only from Concord.

Your copy of the complete, new Concord Catalog is ready! It offers you the latest, greatest selection of guaranteed quality RADIO SETS, PHONORADIOS, RADIO PARTS, TEST INSTRUMENTS, BOOKS, TOOLS, AMPLIFIERS AND ACCESSORIES, AMATEUR KITS AND SUPPLIES, ELECTRONIC EQUIPMENT...page after page of post-war-engineered equipment and parts you have long been waiting for. All standard, top-quality lines. Thousands of items. Money-saving prices. And fast service, direct from our two centrally located warehouses in CHICAGO and ATLANTA.

See the first peacetime line of Concord Radio Sets in new, modern cabinets with a host of post-war features. See the thrilling MULTIAMP *Add-A-Unit* Amplifiers, brand new in the field, with sensational new flexibility, fidelity, and power—EXCLUSIVE with CONCORD.

See the vast stock of everything you need in equipment and parts...see them in the new, comprehensive Concord Catalog, just off the press.

Your copy is ready...and it's FREE. Rush coupon today.

CONCORD
RADIO CORPORATION
LAFAYETTE RADIO CORPORATION
CHICAGO 7 ATLANTA 3
901 W. Jackson Blvd. 265 Peachtree Street

CONCORD RADIO CORPORATION

901 W. Jackson Blvd.

Dept. RC-56, Chicago 7, Ill.

Yes, rush FREE COPY of the comprehensive new Concord Radio Catalog.

Name

Address

City State

OL' PROF. SQUEEGEE DID THE JOB

... way back when

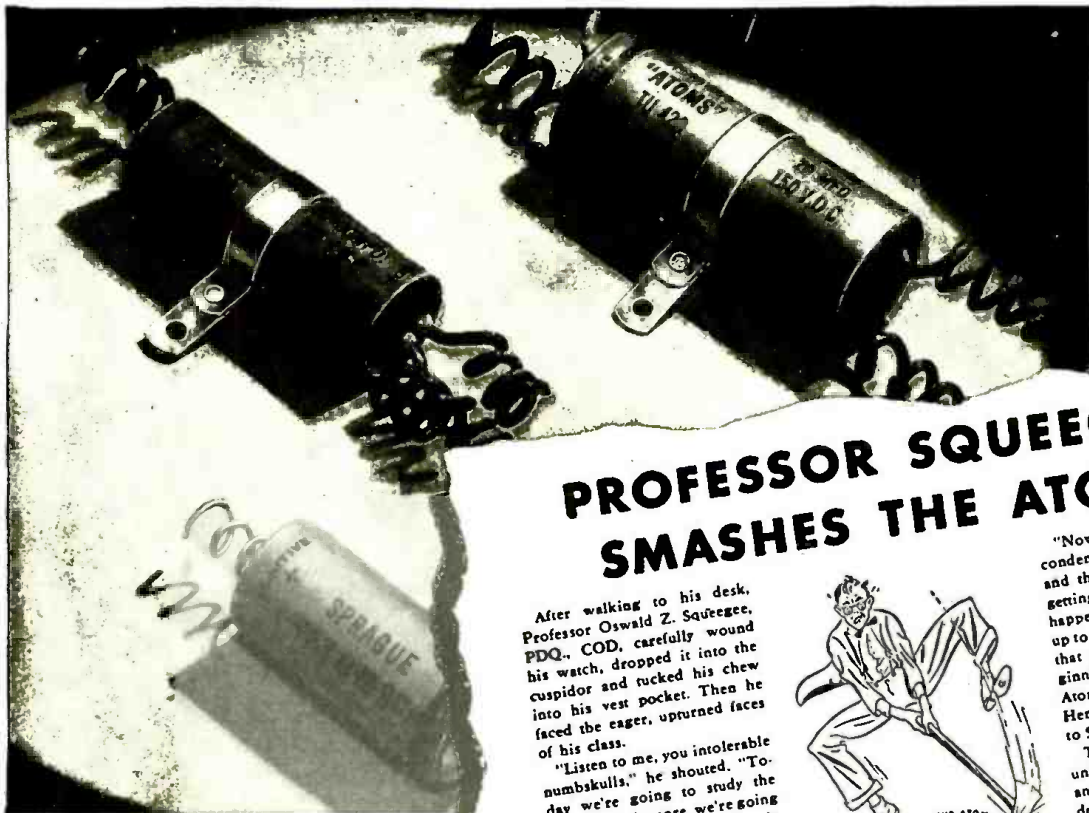

PROFESSOR SQUEEGEE SMASHES THE ATOM

After walking to his desk, Professor Oswald Z. Squeegee, P.D.Q., COD, carefully wound his watch, dropped it into the cuspidor and sucked his chew into his vest pocket. Then he faced the eager, upturned faces of his class.

"Listen to me, you intolerable numbskulls," he shouted. "Today we're going to study the Atom. What's more, we're going to smash the Atom right here in this room. S'help me!"

The Professor paused, reached for a coughdrop, got an eraser by mistake and chewed it vigorously. Then he cleared his throat and continued:

"The Atom, as you ought to know but probably don't, is the unit of all matter. It is the alpha of everything—the smallest, theoretically indivisible portion into which anything can be divided and still maintain its identity. In that respect, it is a good bit like the salaries most of you will earn when you graduate—if you ever do."

"How to smash the Atom has long puzzled scientists, including myself. However, we won't go into that today. Instead, we'll deal with an entirely different type of Atom—the Sprague Atom, a Dry Electrolytic Condenser, appropriately named for its small size and great durability. This, however, is a type of Atom that can be smashed. What's more I'm gonna smash it!"

After ten minutes search, the Professor finally found an 8 mfd. 450 volt Sprague Atom in his cigar case—also a similar midget dry electrolytic of another make. These he connected into a weird electrical circuit on his desk. Then he slowly turned on the juice.



"Now," he gloated, "both condensers are rated at 450 volts and that's exactly what they're getting. As you see, nothing happens. We'll step the voltage up to 500. Now up to 525. Note that the other condenser is beginning to sizzle, although the Atom is still in good shape. Here we go to 550 volts—now to 575—now to—goodness me!"

There came an explosion not unlike that of a giant firecracker and the heads of the class suddenly disappeared beneath their desks.

"You're all wrong," shouted the Professor gleefully after order had been restored. "You thought I smashed the Atom—but I didn't. It was the other condenser that blew up—not the Atom."

Sure enough, the Atom on the desk was still connected—now hissing a bit under the strain of over 600 volts but functioning perfectly.

"The Atom," continued the professor, "is especially protected against blow-outs—against moisture, heat and whatnot. The way to smash the Atom is not merely a matter of overloading it. The way to smash the Atom is this."

The professor grasped an axe hung over a sign "Use only in case of fire." Swinging this with the skill of a woodchopper and shouting wildly all the while he brought the blunt end down on the Atom—again and again and again.

"There!" he screeched, gleefully looking at the shattered remains. "We've done it. We've succeeded where others have failed. That, gentlemen, is how to smash the Atom. Class dismissed."

A TYPE FOR EVERY DRY ELECTROLYTIC REPLACEMENT NEED

Professor Oswald Z. Squeegee is peeved. Extracts from a recent letter carefully typed on asbestos paper and perfumed with brimstone follow: "Listen here, you jerks. Isn't it about time I got credit as the first man, or reasonable facsimile thereof, ever to smash the Atom? Blow the dust off your files and you'll find I did the job way back in 1940 long before most folks even knew an atom from a dehydrated potato..."

And ol' Prof. Squeegee is right! Here-with is reprinted the Sprague advertisement of almost six years ago wherein mention was first made of his startling achievement. Credit where credit is due!

(NOTE: Sprague Atoms are even better today than when Prof. Squeegee performed the most famous experiment. Would he accept a challenge to repeat it now?)

SPRAGUE PRODUCTS COMPANY

NORTH ADAMS, MASS.

JOBING DISTRIBUTING ORGANIZATION FOR PRODUCTS OF THE SPRAGUE ELECTRIC CO.

SOON WE'LL PHONE HOME FROM AUTO

RADIO INDUSTRY POISED FOR BOOM

Big Boom in FM Broadcasting

Seen

MARKET FOR 100 MILLION RADIOS REVEALED BY SYLVANIA SURVEY

COAST TO COAST NETWORK BEING PLANNED FOR FM

RADAR FUTURE

Let TODAY'S HEADLINES Guide You to TOMORROW'S OPPORTUNITIES

Learn RADIO ELECTRONICS DeFOREST'S MODERN "A-B-C" WAY .. at Home



YOU CAN BUILD 133 FASCINATING EXPERIMENTS WITH THIS EQUIPMENT

Plan your future the way business men do: Watch the headlines! Pick a field that's "in the news"—one with many opportunities for interesting, PROFITABLE EMPLOYMENT or a good chance for establishing a BUSINESS OF YOUR OWN with little capital. Pick a field that offers a variety of interesting opportunities—a field with one of America's most promising futures... and see how you may MAKE YOUR START TOWARD A PLACE IN THIS FIELD BEFORE JOB COMPETITION BECOMES ACUTE. Write for DeForest's Big, Free, Illustrated Book—"VICTORY FOR YOU." Learn how DeForest's prepares you at home, in your leisure time—without interfering with the work you are now doing—then helps you make your start in the vast BILLION DOLLAR Radio-Electronics field.

You Get EMPLOYMENT SERVICE

DeForest's Employment Service offers you the advantage of long and favorable contacts with some of America's foremost Radio-Electronics concerns. "VICTORY FOR YOU" tells you how this Service has helped many to their start in Radio-Electronics. You'll see how DeForest students and graduates are prepared to win and to hold good paying jobs—how DeForest students start businesses of their own with little, if any, capital.

A You "LEARN-BY-DOING" at Home with Practical Equipment

Enjoy a "Home Laboratory." DeForest's provides 8 BIG KITS OF RADIO ASSEMBLIES AND PARTS to give you valuable practical experience at home. Build modern Radio Receivers and Circuits that operate. Build Electric Eye Devices, an Aviation Band Receiver, a Public Address System, a Wireless Microphone and numerous other fascinating experiments—in fact, 133 in all, in your spare time at home. NEW colorful Kit Supplement tells you about DeForest's "Home Laboratory," and how you use valuable Radio parts and sub-assemblies to get real practical experience as you learn.

DeFOREST'S TRAINING INCLUDES INSTRUCTION IN MOTION PICTURE SOUND EQUIPMENT, FM RADIO AND TELEVISION...

C WELL-ILLUSTRATED LOOSE-LEAF LESSONS

DeForest's provides 90 loose-leaf lessons prepared under the supervision of the man often referred to as the "Father of Radio"—Dr. Lee DeForest, inventor of the Audion Tube, and holder of over 300 important patents. . . . ACT PROMPTLY! See how you can learn Radio the

modern A-B-C DeForest's way—by Reading . . . by Doing . . . by Seeing at Home. Mail coupon Now!

B Home MOVIES Help You Learn FASTER...EASIER

With DeForest's, you use a genuine DeVRY 16 mm. Motion Picture Projector and exciting training films to help you learn some of Radio's fundamentals FASTER . . . EASIER. SEE what happens inside of many circuits you are working on. SEE how electrons function. SEE how RADIO waves are changed into sound. Get DeForest's big, free book! Use it as a key to show you the way to Radio-Electronics job opportunities of today and tomorrow—the opportunities the headlines tell about.

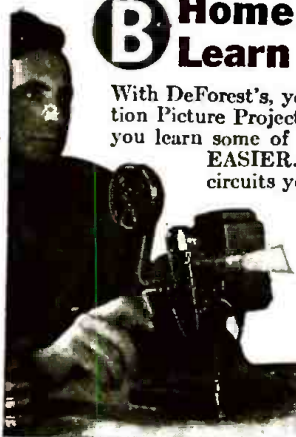

SEND FOR FREE BOOK & SUPPLEMENT TODAY!

DeFOREST'S TRAINING INC., Chicago, Ill.

DeFOREST'S TRAINING, INC., 2533-41 N. Ashland Ave., Dept. RC-C5 Chicago 14, Illinois, U. S. A.

Send me both your big book "VICTORY FOR YOU" and Kit Supplement, showing how I may make my start in Radio-Electronics with your modern A-B-C home training plan. No obligation.



Name _____ Age _____

Address _____ 1 pt. _____

City _____ Zone _____ State _____

If under 16, check here for special information.

If a discharged veteran of World War II, check here.

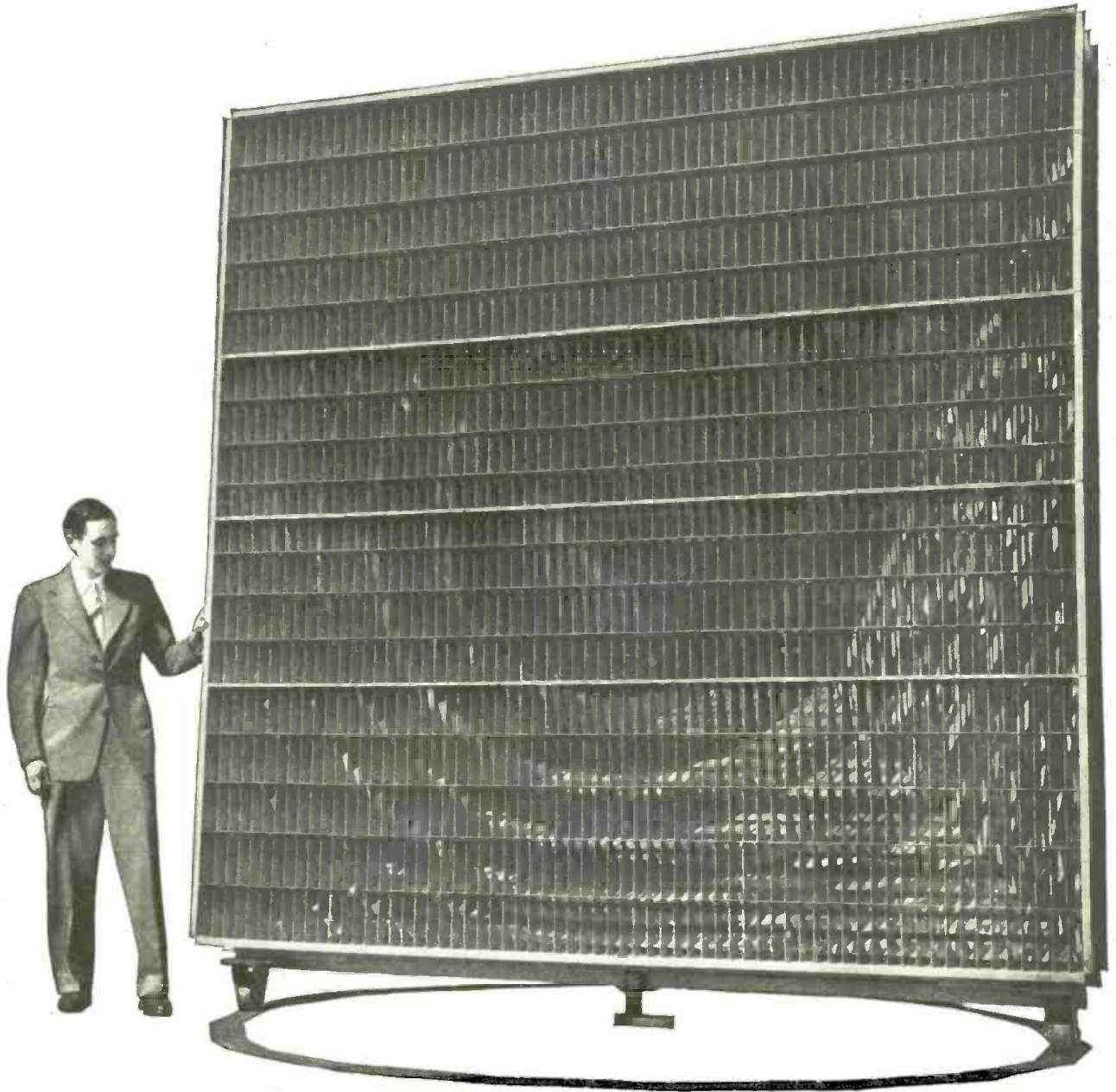

● **A "SEARCHLIGHT" TO FOCUS RADIO WAVES**

In the new microwave radio relay system between New York and Boston, which Bell Laboratories are developing for the Bell System, giant lenses will shape and aim the wave energy as a searchlight aims a light beam.

This unique lens—an array of metal plates—receives divergent waves through a waveguide in the rear. As

they pass between the metal plates their direction of motion is bent inward so that the energy travels out as a nearly parallel beam. At the next relay point a similar combination of lens and waveguide, working in reverse, funnels the energy back into a repeater for amplification and re-transmission.

A product of fundamental research on waveguides, metallic lenses were first developed by the Laboratories during

the war to produce precise radio beams.

This "searchlight" is a milestone in many months of inquiry through the realms of physics, mathematics and electronics. But how to focus waves is only one of many problems that Bell Telephone Laboratories are working on to speed microwave transmission. The goal of this and all Bell Laboratories research is the same—to keep on making American telephone service better and better.



BELL TELEPHONE LABORATORIES

Research and Development in Telephony • Telegraphy • Television • Wire Transmission • Radio • Aided by Physics • Chemistry • Acoustics • Mathematics • Electronics • Metallurgy • Magnetism • Microchemistry • Electron Dynamics • Spectroscopy • Vibration Mechanics • Statistics • Crystallography • Fundamental Studies in Speech and Hearing • Lubrication • Contact Alloys • Electrical Measurements • Corrosion and Decay • Quality Control • Design of Antennas • Cable • Capacitors • Coils • Cords • Dials • Microphones • Networks • Outside Plant Apparatus • Resistors • Vacuum Tubes • Circuit and System Design for Crossbar • Panel • Step-by-Step • Manual • Amplifiers • Modulators • Oscillators • Repeaters • Gain Control

Grasp the **NEW OPPORTUNITIES** in

RADIO ELECTRONICS AND TELEVISION NOW!



Modern Radio — F M broadcast and reception —
Television — Radar — Industrial Electronics;
power, control, communications—new equipment
and methods demand new technical ability and
experience. Keep up to date with the latest.

**MODERN ELECTRONIC
LABORATORY FOR YOU
TO USE AND KEEP**

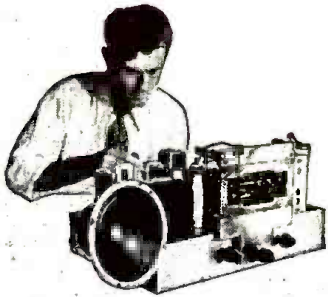

The very essence of National Shop Method Home Training is **EXPERIENCE**. You get the actual experience by working with modern Radio and Electronic equipment—building circuits and instruments. You may build a fine, long distance **MODERN SUPERHETERODYNE** signal generator, miniature radio transmitter, audio oscillator—many other full sized, actual, operating pieces of equipment and instruments—conduct cathode ray and hundreds of other experiments. This experimental laboratory work advances with your training and you actually learn by doing. Send the coupon and get the full details of how such an offer can be made.

Shop Method Home Training

By a Great Established Resident School

Get one of the thousands of **NEW JOBS** that demand new techniques and methods in modern radio. Get your share of the **NEW BUSINESS** that servicing the new sets and equipment demands. Experts agree that Radio Television and Electronics presents the next great industrial boom!

Radio is expanding farther and faster than ever with great improvements in reception. Radar is already a 2-billion dollar a year business. No one knows yet how great the Television market will be. Electronics touches almost every walk of life—in industry and in the home.

TURN YOUR INTEREST IN RADIO INTO A CAREER THAT WILL ASSURE YOUR SUCCESS. Mail the coupon below for a list of the great opportunities in this field—today and in the near future.

Get the Proper Training

The good jobs in Radio Electronics now go to the men who are equipped to handle them. It takes training and experience. National Schools, one of the oldest and best established technical trade schools in the country, makes it possible for you to get this training and experience right in your own home **IN YOUR SPARE TIME.**

Learn right! Get the latest short cuts, trade secrets, straight information.

National maintains one of the biggest resident training shops and laboratories in the United States where instructors, scientists and engineers are working constantly to improve and advance training methods. **SHOP METHOD HOME TRAINING** is a logical extension of this practical system.

A **FREE** lesson that shows you how practical and systematic—how sound, simple and easy this new training method is will be sent you without obligation. You may keep and use this lesson as you see fit. Fill out and mail the coupon below.

Investigate this Proposition

Where do you stand today in modern industrial progress? What does the future hold for you? You owe yourself this opportunity. It may never come again. With National Training **YOU GET AHEAD FAST**—you may step into a good position or start a business of your own, with little or no capital, even before you complete your National course.

Fit yourself for a career of independence, good earnings, a lifetime of success and security in one of the fastest growing fields in the World. But make up your own mind. Get the information first hand. Put your name and address on the coupon and mail it today.

FREE LESSON



Get This Book FREE

This big book presents the facts about the field of electronics and your opportunities in it together with full information about the advanced National Training. Read it and make up your own mind that National Training will equip you for a great future. No salesman will call on you from National. The book is **FREE** with your sample lesson. Send the coupon or write.

See What National Training Has Done For These Men!

National Shop Method Home Training wins good jobs, independence and security quickly. Take the word of National men who have established records in their favorite Radio, Television, or other branches of Electronics:



Joseph Grumlich, Lake Hiawatha, New Jersey writes: "My latest offer was \$5,800.00 as Radio Photo Engineer but I'm doing well where I am now engaged. I am deeply indebted to National."

Here's a statement from R. R. Wright, Blackfoot, Idaho: "Due to my training at National I was selected to instruct in the laboratory work of Navy and Marines."



From O. K. Ivey, Washington, D. C., comes this endorsement: "I believe National offers the best course to be had. Keep up the good work."



Robert Adamsen, Kearney, Nebraska, National graduate, has two radio jobs—makes double pay as a radio instructor and as engineer at Station KGFW. He writes: "I am proud of My National training and appreciate the co-operative spirit."



Read what hundreds of other enthusiastic students have written about National Training. Send in your coupon today.



NATIONAL SCHOOLS

LOS ANGELES 37, CALIFORNIA EST. 1905



MAIL OPPORTUNITY COUPON FOR QUICK ACTION

National Schools, Dept. RC-5
4000 South Figueroa Street, Los Angeles 37, California

(Mail in envelope or paste on penny post card)

Mail me **FREE** the two books mentioned in your ad including a sample lesson of your course. I understand no salesman will call on me.

NAME AGE

ADDRESS

CITY STATE

Include your zone number



Mr. Radioman: **Here's How Capitol Radio
Can Prepare You Now for a Better
Job and a Secure Career in Radio-
Electronics . . . !**

**Add CREI Technical Training to
Your Present Experience—Then
Get that Better Radio Job You
Want—More Money, Security!**



CREI home study training in Practical Radio-Electronics Engineering equips you with the ability to go after—and get—a better job in radio-engineering that offers security, advancement and importance.

We are now entering a period where employers can once again afford to be "choosy" in selecting the best-qualified men for the important jobs to be filled.

In our proved course of home study training, you learn not only *how* . . . but *why*! Your ability to solve tough problems on paper, and then follow with the necessary mechanical operation, is a true indication that you have the *confidence* born of *knowledge* . . . confidence in your ability to get and to hold the type of radio job you want.

CREI courses have been studied by more than 10,000 professional radiomen—so don't say YOU haven't the time. CREI courses are designed to be studied in the most crowded schedules—without in-

terfering with your present work, yet helping you as you progress lesson by lesson.

Now you can read what these typical CREI students have to say. They are men who had the initiative to get started on their own betterment program toward better jobs and more money. You have the same opportunity. It costs you nothing but a moment's time to send for complete details in free book.

"I give CREI full credit for my securing the position as Asst. Chief Engineer . . ."

W. H. MEINERS, 420507

"In the past 7 months I have received 3 increases in salary and a promotion that can be partly credited to CREI . . ."

C. B. MCKNIGHT, 401101

"There are many times where what I am studying in the course works right in with the immediate problems of my job . . ."

C. I. CARPENTER, 411024

CREI Training for Veterans is Approved Under the "G.I." Bill

CAPITOL RADIO Engineering Institute

E. H. RIETZKE, President

Dept. RC-5, 3224—16th Street, N. W., Washington 10, D. C.

Branch Offices:

NEW YORK CITY (7)
170 Broadway

CHICAGO (2), ILL.
30 N. LaSalle St.

SAN FRANCISCO (2),
CALIF., 760 Market St.

SAN DIEGO (1), CALIF.
316 C Street

• WRITE
TODAY for
FREE
BOOKLET



"Your Opportunity in the
New World of Electronics"

If you have had professional or amateur experience—let us prove to you that we have something you need to qualify for a better radio job. To help us to intelligently answer your inquiry—PLEASE STATE BRIEFLY YOUR BACKGROUND OF EXPERIENCE, EDUCATION AND PRESENT POSITION.

Member: NATIONAL HOME STUDY COUNCIL • NATIONAL COUNCIL OF TECHNICAL SCHOOLS

RADIO INDUSTRY UNFAIR?

Facts in the case of Ex-Serviceman vs. Radio Manufacturer

For a number of months now, RADIO-CRAFT has been receiving an increasing number of communications from ex-servicemen who write bitter letters indicting the radio industry—from manufacturer to distributor on down—accusing it of unfair practices in shutting out servicemen from sharing in the radio business, to which they believe themselves rightfully entitled.

Many servicemen state that they sold their own radio business, then went into the service, only to return and find that they are now shut off from their former and other supply sources. Some state that upon returning home, they opened a new store, or a new establishment, and since then have fought a losing battle to secure representation for some radio set or some radio supplies.

They wrathfully contend that they meet with no success and that the usual answer is: "We are extremely sorry, but we have no open territory at the present time, and cannot open new accounts now."

Naturally, the men cannot be blamed for voicing their extreme annoyance at all this. Many state that they are the holder of a Silver Star, Air Medal, Purple Heart, and similar decorations, and they feel that the radio industry has let them down badly. They usually end up by stating: "What really did we fight the war for?"

Frequently the letters become extremely caustic, as has been attested by a number which have been printed in RADIO-CRAFT'S "Communications" section.

It is not a simple matter to dispose of these letters with a blanket answer, because most cases differ and no single answer could possibly cover all of the different ones.

Unfortunately, many of the ex-servicemen who write these wrathful letters are not quite fair themselves. In the first place, many of the writers never had a radio set agency before they went to war, and they, therefore, do not understand the requirements of most radio manufacturers.

There is first the matter of credit. Radio set manufacturers give agencies or dealerships only to those who are financially responsible, because the radio manufacturers do not do a cash business. That means that the customer is usually billed on, say 30 or 60 days' credit, as the case may be. If the store proprietor has no financial rating, the manufacturers naturally will not be inclined to extend credit. That is true in every line.

The ex-serviceman appreciates the fact that just because he served his country, and served it well, it does not follow that this entitles him to a financial credit if he has no established credit.

We believe this to be elementary, but it is often lost sight of. We know as a fact that many ex-servicemen, who had been in the business before, and who had a credit standing previously, find little difficulty in re-establishing themselves with their old suppliers. It is when a new man, who had no previous credit standing, comes along that the difficulty begins.

Not so long ago we investigated a deserving ex-serviceman who had written in to us in a similar vein as that pointed out above. He, too, bemoaned the fact that he could not

get an agency. We ascertained that this man did not have a regular store, but was a radio serviceman. He owned a tiny establishment and was strictly in the repair business before the war. He had never handled radio sets before. His location was also against him because he was in a residential section where there are no stores. For this reason the radio manufacturer could not grant a dealership to him. This man's credit standing, however, was favorably known, and the set manufacturer suggested to him that if he could open a new store somewhere near or in a business section, where there would be a chance of selling quantities of sets, they would be interested in granting a dealership. From this it will be seen how difficult it is to judge such cases. No two are alike.

Then once more, we must come back to what we said editorially in our November issue—the approach of the ex-serviceman to the manufacturer.

In that issue we stated that no manufacturer will pay any attention to handwritten letters on blank sheets of paper. It is a serious reflection on the ex-serviceman who has not sufficient pride to get up a good letterhead and at least keep up appearances. We find that many of the letters which arrive here—and among these are the most bitter—are badly composed and are rarely on a decent letterhead. No one, therefore, could be surprised that radio manufacturers or their distributors pay scant attention to such un-businesslike communications.

Some of the writers seem to have an idea that RADIO-CRAFT will always defend the radio manufacturer no matter what he does. That, of course, is not based upon facts.

Unfortunately, it IS true that a number of radio manufacturers today have so much business that they can be choosy. They usually are understaffed, and if some minor clerk gets a letter which he does not consider of sufficient importance, it may go unanswered.

On the other hand, it must also be admitted that deserving ex-servicemen, who have a satisfactory rating, have also been turned down. Here the fault does not lie with the ex-serviceman, but with the manufacturer. Unfortunately, too, there are a number of unpatriotic radio manufacturers in business, and they deserve severe censure. However, it must be said that if the case of the ex-serviceman is intelligently put before a higher official of a radio manufacturer the ex-serviceman usually will get what he was after.

Just writing one letter does not turn the scales of success. A personal call may be necessary. There is also the telephone. If the ex-serviceman uses his ingenuity and his resourcefulness and can get the attention of a manager or assistant manager, we feel certain that his cause will, in most cases, get the attention that it deserves.

The ex-serviceman must understand that thousands are fighting for the same thing that he is, and it is often quite impossible for an official to know who is an ex-serviceman and who is not. It is up to him to use sufficient pressure and resourcefulness to make himself heard.

All of this, however, is only half of the story. What good

(Continued on page 559)

BROADCASTING VIA THE MOON

from one part of the earth to another, described in last month's issue of *Radio-Craft* (page 503) as a Gernsbackian prediction from the year 1927, may become a reality if a plan announced last month by Federal Telephone and Radio Corporation is put into effect. Scientists of that company consider the establishment of communication between distant points on the earth by using the moon as a reflector "entirely feasible in the not-too-distant future."

It is obvious that a transmission emanating from any point, beamed at the moon and reflected back to the earth, would strike all points on the side of the earth turned towards the moon with substantially equal intensity. Since the radio waves strike the receiver from above, natural obstacles between the transmitter and receiver would have no effect. Therefore, the blocking action of the curvature of the earth, mountains, cities and other obstacles to high frequency line-of-sight transmission will be eliminated.

The range of a powerful television broadcasting station would be *hemispheric*. Reception of American television broadcasts would be equally good throughout South America, Canada and Alaska, as well as Europe and a large part of the Pacific. The only requirement would be that the receiver be within sight of the moon at the same time as the transmitter. More remote stations would therefore, have less available time for reception, and the maximum operating time for any station would be 12 hours per day and regularly changing. This is a factor with which radio and television have not heretofore had to contend.

The advantages of moon-reflected transmission would be manifold, especially those due to the use of very high frequency transmission allowing for a considerable number of channels. At present the band width of the receiver is narrow, thereby limiting the transmission to code messages, but probably future developments will overcome this disadvantage, when higher power transmitters become physically and economically feasible. Fantastic developments may then enter the realm of reality.

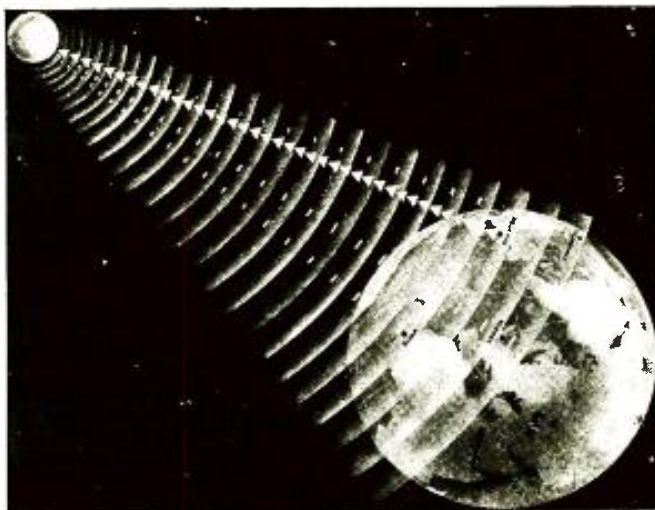

RADIO-ELECTRONICS

Items Interesting

FM DX RECORDS were hung up during a contact last month between an electric power company station in Winnipeg, Canada, and an ensign on the USS LC1 1000, at the time 200 miles south of Jamaica.

A long conversation was carried on without difficulty over this distance, which is more than 2500 miles. More remarkable was the fact that the set used on shipboard was a low-power Navy portable with a normal range of approximately 15 miles. The Winnipeg station was a larger unit used to communicate with outlying power stations as well as with service and repair cars.

"NUCLEAR NONSENSE" was the description applied last month to the popular idea "that atomic energy will presently displace all other known sources of power," by H. C. Meyer, president of the Foote Mineral Co. The energy is there, he stated, but in the light of our present knowledge, like the gold in seawater, it costs more to get it out than it is worth.

A second fallacy attacked by Mr. Meyer was the supposition that secrecy concerning atomic power can be maintained by legislative action. "It is utter nonsense for any group or nation to attempt to control the knowledge of atomic energy developed during the war," he said. "Explosive atoms and explosive ideas cannot be imprisoned or outlawed by government edict."

AMATEUR CONTACTS on the microwave bands were reported last month. Amateurs W6BMS and W2LGF, using the 5250 to 5650 megacycle band, were able to establish contacts over a distance of 31 miles. This is the first reported use of these bands by anyone other than military and commercial services.

Parabolic reflector antennas and Klystron tubes were used in the apparatus.

THE MEDAL FOR MERIT was presented last month to Brigadier General David Sarnoff, RCA's president, by Major General H. C. Ingles, Chief Signal Officer of the Army, who represented President Truman at a presentation ceremony held at Radio City, New York.

General Sarnoff was previously awarded the Legion of Merit on October 11, 1944, for "exceptional meritorious conduct in the performance of outstanding service" when he was on military service overseas. The present decoration



Maj.-Gen. H. C. Ingles and Brig.-Gen. Sarnoff.

was a tribute to his civilian activities as head of a great radio corporation. The citation, signed by President Truman, said (in part): Mr. Sarnoff placed the full resources of his company at the disposal of the Army whenever needed, regardless of the additional burden imposed upon his organization. He encouraged key personnel to enter the service, and at his direction RCA engineers and technicians rendered special assistance on numerous complex communications problems. He fostered electronic advances which were adapted to military needs with highly beneficial results. The wholehearted spirit of cooperation which Mr. Sarnoff inculcated in his subordinates was of inestimable value to the war effort.

HAM STATIONS are again being licensed, it was announced last month by the American Radio Relay League. The FCC has resumed licensing of amateur radio stations after suspending this service at the outbreak of the war.

Prior to Pearl Harbor, there were 60,000 amateur radio station licenses in the United States. It is estimated that this number will increase to 250,000 in the next five years due to the upsurge of interest in amateur radio communication created by the war.

Signals transmitted from a single point on the earth would be reflected back from the moon in a broad wave which would almost cover a hemisphere.

MONTHLY REVIEW

to the Technician

PLANE-BORNE TELEVISORS were valuable as reconnaissance agents in the Pacific struggle, it was revealed last month at a Navy demonstration at Anacostia, D. C. Two types of televisors,



The compact "Block" camera unit out of its base.

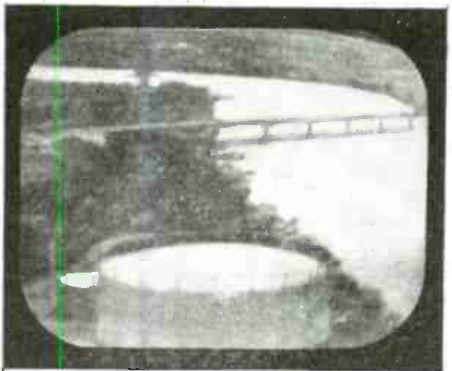

Official Navy Photo

Scene on the Potomac televised from a plane.

the "Block" and "Ring" systems, were demonstrated.

The Block transmitter is a camera weighing only 75 pounds, and is designed for short-distance work. The Ring transmitter is a larger unit, designed for long-distance work, uses two cameras, weighs upward of 500 pounds, and is capable of high-quality television production. In tests over Washington last year, Ring transmitted excellent images over a 200-mile radius from an altitude of 22,500 feet. Even at dusk, it was possible to observe movements of traffic and recognize landmarks without difficulty.

Wartime use of the two systems included as "eyes" in remote-controlled planes, flying bombs and "crash" boats; observation of gunfire, mapmaking and general reconnaissance work; transmission of messages, maps and charts, between ships or aircraft.

Planes transmitted from 6,000 feet views of Baltimore and other scenes (one of which is reproduced here) to Navy and Press representatives at the Naval Air Station in Anacostia. With

ten channels an equal number of planes can transmit ten similar views of a battlefield to screens at a General Headquarters, giving staff officers a complete view of the scene. (The picture is reminiscent of one pictured in *The Experimenter* for November, 1924, in which Hugo Gernsback envisioned a six-panel screen, on which Army officers would view television images from each of the six cardinal directions, meanwhile directing the plane by radio control. Both the television and the radio control features were actually used during the later stages of the recent war; press representatives were informed.)

Brigadier General Sarnoff, president of RCA, which developed the system in cooperation with the Navy, predicted wide peacetime use for the equipment. Among other applications, he pointed to: revolutionary television news coverage over short and long distances from cars, boats, planes and helicopters; safeguarding the lives of test pilots by replacing them in experimental planes where there is a risk element; transmission of terrain images to incoming planes (or ships) whose pilots might be unfamiliar with the region; industrial applications as watchers where peril from heat, chemical or radioactive processes or other causes would render human observation impossible; and exploration, either over hazardous terrain or deep beneath the ocean surface.

This latter application is adapted to recovery of sunken treasure at depths too great for divers, or for monitoring machines working under water.

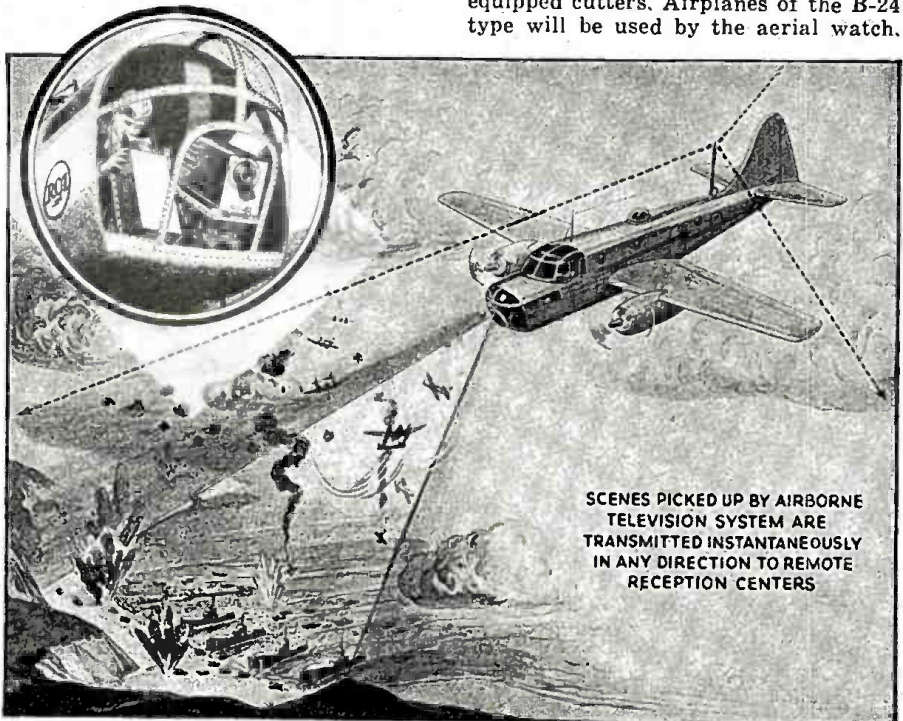

SCENES PICKED UP BY AIRBORNE TELEVISION SYSTEM ARE TRANSMITTED INSTANTANEOUSLY IN ANY DIRECTION TO REMOTE RECEPTION CENTERS

MESONS produced artificially for the first time in a laboratory were announced last month by General Electric engineers. Using X-rays from the company's new 100,000,000-volt betatron, physicists have succeeded in producing this short-lived particle heretofore found only far above the earth's surface. The betatron has opened to science a new energy range, between 40 and 100 million volts.

The meson, hitherto known only through cosmic ray studies, is a particle considerably more massive than the electron, though lighter than the proton. Mesons are produced in the atmosphere high above the earth's surface by the primary cosmic radiation from outer space and last, on the average, but a few millionths of a second.

ICEBERG DETECTION with war-developed radar and loran will be a feature of the re-established International Ice Patrol, it was announced last month by the Coast Guard. The Ice Patrol, which maintained a continuous watch of the danger areas of the North Atlantic during the iceberg season, was discontinued in 1941, though a careful estimate of ice conditions was maintained throughout the war for the benefit of naval vessels and convoys.

The radar will assist in locating icebergs during periods of low visibility. Loran will give the exact location of a berg as soon as discovered. This is important. In the past, patrol vessels have been fogbound for days. Their position had to be determined by dead-reckoning and radio-direction-finder bearings. With the use of loran, the patrol vessel's position can be determined within approximately one mile and warning given of the position of an iceberg sighted. Loran will also afford a more efficient means of tracking bergs in their daily movements.

A constant patrol of the region will be maintained by aircraft and specially equipped cutters. Airplanes of the B-24 type will be used by the aerial watch.

DEMONSTRATION DEVICES

A.C. Phase and Vectors Made Visible

FREQUENCY modulation or FM is famed for staticless, high fidelity reception; and has been rapidly increasing in importance, promising even greater growth in the future. The discriminator and limiter constitute the main differences between amplitude modulation receivers and FM receivers. Discriminator circuits are also part of automatic frequency control or a.f.c. systems, as well as being employed in some FM transmitters. This importance of discriminators merits some time and effort toward understanding their action.

The *Foster-Seeley* discriminator produces voltage reversals from radio frequencies changing at an audible rate, by using certain phase relationships. To make these phase relations more readily understandable the radio frequencies are slowed down from millions of cycles to about *forty cycles per second* and the modulation or changing of this frequency is slowed down from audio rates of thousands per second to a *manually controlled change* spread over many seconds. This slowing down enables the carrier phase changes to be studied by stroboscopic illumination. The voltage changes, resulting from the modulation of the carrier frequency, can be observed by the unaided eye.

AC VECTOR REPRESENTATION

The first requisite in understanding discriminator operation is a knowledge of the effects of capacity and inductance

upon the phase of alternating current. Facility in using the concise and convenient representation of alternating current by vectors is also a great asset to student and engineer.

Photo A shows a device described by C. V. Drysdale in his book "The Foundations of Alternating Current Theory" (Edward Arnold—London), for drawing alternating current or voltage curves identical to the sine curves observed experimentally on an oscilloscope. The pencil which traces the sine curve is actuated by a Scotch yoke (not a Swedish dialect pun) but a slotted T mechanical linkage driven from a pin inserted at the tip of an arrow which is a radius of a disc rotated by hand. The disc's shaft, after passing through a supporting bearing, carries two worms from an old dial drive. Dial cable secured to, and winding around these worms as a capstan, passes around pulleys mounted on the back of uprights at each end of the frame, to terminate on the sliding board which carries the paper. Thus as the disc turns the dial cable pulls the sliding board and paper along to provide the time axis of the sine curve. Note that the sliding board has most of its sides cut away so that it bears on the guide grooves only at its four corners. This is done to reduce friction.

With this device draw a sine curve by rotating the wheel. Then draw a second arrow 120 degrees or one third the way around the disc from the first

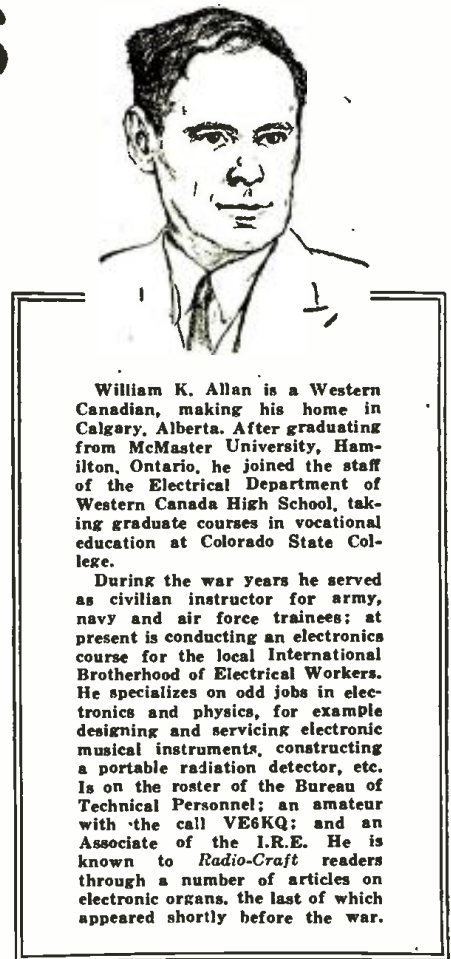

William K. Allan is a Western Canadian, making his home in Calgary, Alberta. After graduating from McMaster University, Hamilton, Ontario, he joined the staff of the Electrical Department of Western Canada High School, taking graduate courses in vocational education at Colorado State College.

During the war years he served as civilian instructor for army, navy and air force trainees; at present is conducting an electronics course for the local International Brotherhood of Electrical Workers. He specializes on odd jobs in electronics and physics, for example designing and servicing electronic musical instruments, constructing a portable radiation detector, etc. Is on the roster of the Bureau of Technical Personnel; an amateur with the call VE6KQ; and an Associate of the I.R.E. He is known to *Radio-Craft* readers through a number of articles on electronic organs, the last of which appeared shortly before the war.

arrow. Insert the Scotch yoke driving pin at its tip, and trace a second sine curve, which with the first curve drawn represents two phases of a three-phase alternating current. When two three-phase sources are connected in additive series, what is the total voltage? Well,

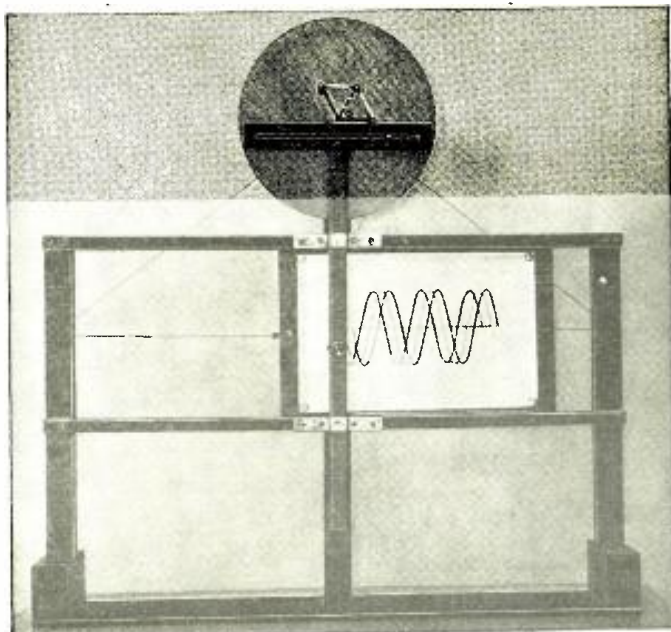
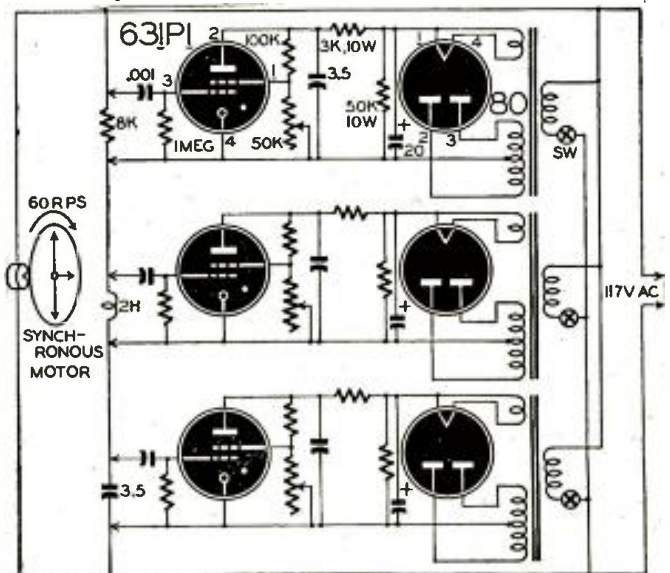

Photo A—The Scotch Yoke for demonstrating alternating current. Below, Fig. 1—The three Strobotrons with their power supplies.



draw a zero axis on the paper, and at a number of points along this axis, add the heights of the two sine curves, treating distances below this zero axis as negative. Joining all points so located by a dotted line, results in a new sine curve of the same height half way between the two already drawn. Thus 1 volt when added to 1 volt differing in phase by 120 degrees produces 1 volt. An example of this in practice is found in a 3-phase delta connection where series addition of 220 and 220 volts results in 220 volts.

This answer so laboriously obtained can be found immediately if either arrow is moved only along its own length or diagonally sideways, *without changing its direction or length*, until its tail is on the point of the other arrow. With a pin at the point of either moved arrow (if moved sideways to the positions shown by the white lines) a sine curve is traced which is the sum of the two curves represented by the arrows, as shown in the photo A.

Now a quantity which requires direction as well as magnitude to describe it is called a vector. For example, voltage, velocity and force are vectors whereas mass, density and volume are non-vectors. Thus we have a mechanical proof that alternating voltage may be represented by a vector (arrow) imagined to be rotating counter-clockwise, with perpendiculars from its point to the starting line, giving instantaneous values of voltage. **BY PRESERVING BOTH DIRECTION AND MAGNITUDE, VECTORS MAY BE ADDED IN PLACE OF THE SINE CURVES THEY REPRESENT.**

THE VECTORSCOPE

Having vector notation clearly in mind, let us now put it to use to describe the effect of condensers and coils on alternating current and voltage. Photo B shows a vectorscope described by Lawrence G. Betz in the February 1944 issue of *Electronics*. It consists of an arrow which is a radius of a disc rotating clockwise 60 revolutions per second. (A set of 2-1 silent, fiber, automobile timing gears on an 1800 r.p.m. synchronous motor from an obsolete mechanical X-ray rectifier is used.)

Three SN4 or 631P1 stroboscopy tubes, or cold-cathode neon-filled tubes, are each connected across a condenser kept charged to just below the stroboscopy tube's ionizing voltage, by three independent d.c. power supplies. A positive charge on any stroboscopy tube's grid causes its neon gas to ionize, so discharging its con-

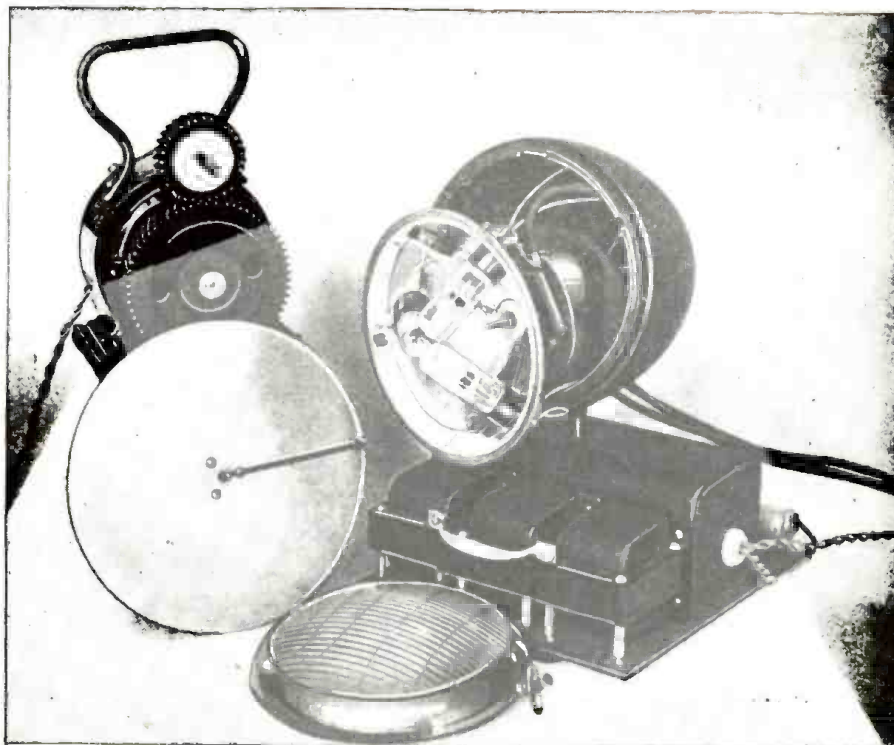

Photo B—The Vectorscope. Left—The revolving arrow. Right—Stroboscope illuminating unit.

denser with a current of hundreds of amperes lasting a few millionths of a second but producing a very intense flash of light of such extremely brief duration as to apparently arrest the motion of any object illuminated by it. The grid and cathode of a stroboscopy tube are connected across: a coil, a resistor, and a condenser, which are in series across the 115-volt 60-cycle line. See Fig. 1. They are visible behind the headlamp housing of the stroboscopy tubes in Photo C.

The synchronous motor rotating the arrow is started and the screen control of the stroboscopy tube connected across the resistor is adjusted until the peak of the alternating current sine wave creates just enough voltage drop across the resistor to fire the stroboscopy tube, as is evidenced by the arrow appearing

stationary at the point of its revolution when the a.c. is most positive. If necessary, stop the motor and adjust the disc so this resistor voltage vector will appear horizontal with its tip to the right to conform with conventional position.

INDUCTANCE AND CAPACITY

Next turn on the power supply of the stroboscopy tube connected across the induct-

(Continued on page 568)

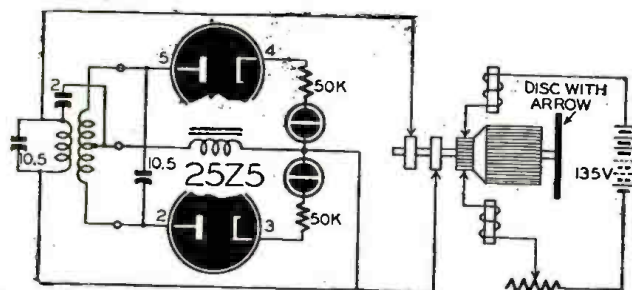
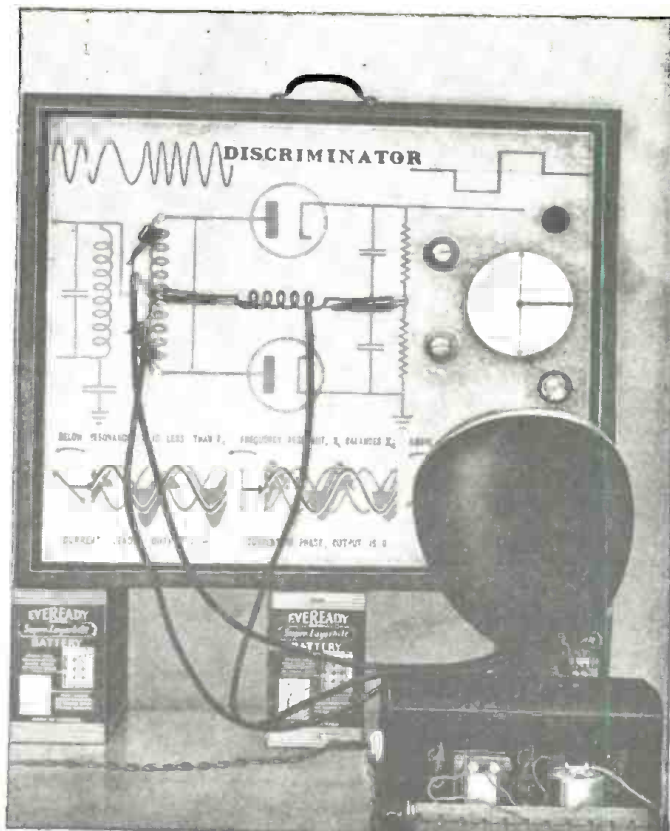

Photo C—Demonstration board with stroboscope unit in foreground. Above, Fig. 2—The discriminator action is similar to that of a frequency-modulation detector, but at very much lower frequencies.



MULTIPURPOSE TESTER

Is Volt, Ohm, Mil and Capacity Meter and Signal Tracer

THE experimenter will find this seven-tube test unit very useful. It incorporates a four-watt audio amplifier with a built-in dynamic speaker; an r.f. test probe; a twin indicator electron-ray tube with its separate

The socket of the 6B8 tube is fastened to a three-foot six-wire shielded cable. The tube must be shielded if the 6B8-G glass type is employed. Resistor R12 and condenser C15 are mounted on the probe assembly, but all other parts are located within the cabinet. Switch Sw2 turns on the probe.

The 6AF6-G twin indicator tube has both ray-control electrodes tied together so that two similar shadows are produced. The tube was mounted on a bracket with pins 3 and 7 in a vertical plane. Switch Sw3 turns on the target voltage. The 6K7 tube — connected as a triode amplifier — has two variable bias controls. The 1-meg-ohm unit (R15), which has no dial or calibration, serves to set the shadow angle before

making measurements. R16, the 750,000-ohm control, is connected to a four-inch 325° calibrated CA precision vernier dial. The latter unit is used for measurements. The calibrated knob was mounted on top of the cabinet, because in this way the dial reading is not apt to influence the setting of the "eye."

The 6H6 tube rectifies alternating voltages that are impressed on the electron-ray indicator circuit, so that the image will be clear and sharp. Selector switch Sw4 connects the various testing circuits. When the indicator circuit is used in conjunction with the signal tracing amplifier, potentiometer R18 regulates the intensity of the signal affecting the indicator.

The power supply employs a 5Z4 tube in a conventional full-wave rectifier circuit. By using jacks J8 and J9 the "B" supply can be used to operate or test external circuits, if the current requirement is not too large. The neon lamp serves as a safety "B" indicator. If the lamp should go out or glow dimly, the power supply should be turned off because this would probably indicate a short circuit or a dangerously heavy load. If the "B" supply is being used to supply power to a circuit to be tested, the r.f. probe and audio test prod can be used; but it is impractical to use any of the other tests simultaneously.

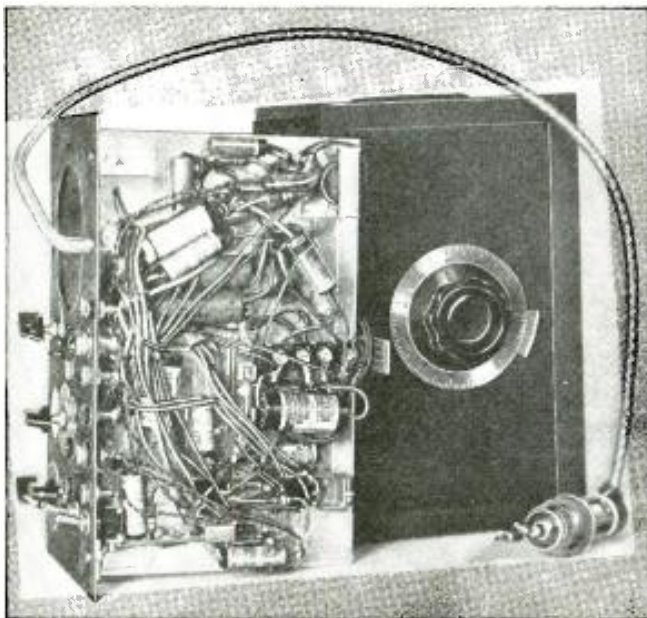

All measurements are made with the calibrated dial and 6AF6 tube

amplifier; and a power supply. The tester will trace a signal from aerial to speaker of a receiver, and give a comparative check of signal intensity. It will measure voltage, current, resistance, and capacity; and also test condensers for open and short circuits.

The test unit was built in a ventilated metal cabinet measuring 12 x 7½ x 7 inches. The chassis was made from a ½-inch sheet of alloy aluminum measuring 11 x 6½ inches. Since the heavy aluminum cannot be bent easily, it was supported and fastened by means of angle irons.

It is essential that extreme care be taken in wiring and constructing the tester. The leads should be well insulated. The jacks that are not grounded to the chassis can be thoroughly insulated by fastening them with live-rubber grommets mounted in the panel.

Toggle switch Sw1 permits the audio amplifier to operate either the speaker or a pair of phones connected to jacks J10 and J11. R3 serves as a volume control and also operates the power supply switch. The grid cap lead from the 6J7 tube should be shielded to prevent pick-up of stray noise and hum.

before making measurements. R16, the 750,000-ohm control, is connected to a four-inch 325° calibrated CA precision

OPERATION OF THE TRACER

Signal tracing is a very convenient system for locating a defective stage in (Continued on page 564)

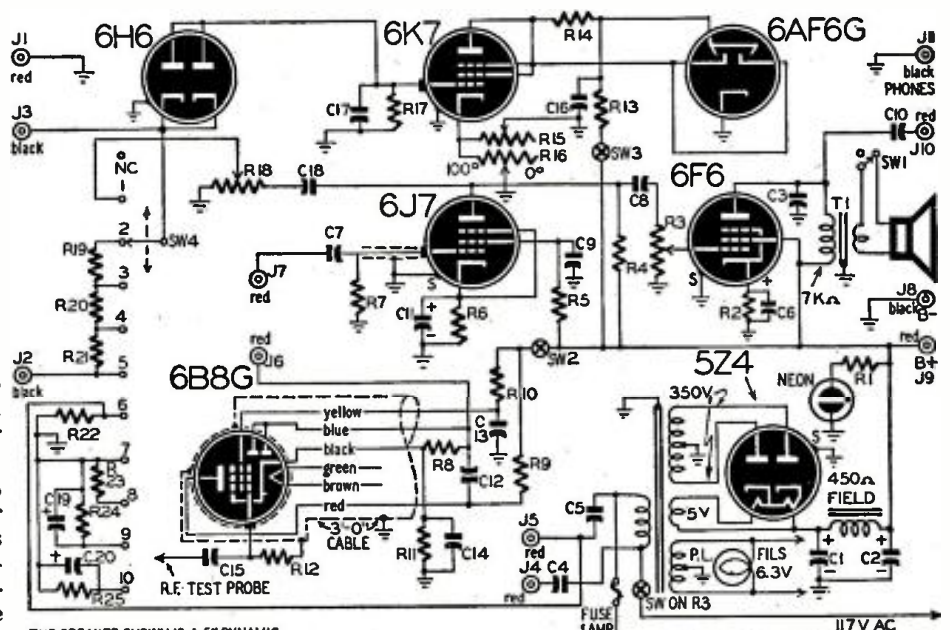

THE SPEAKER SHOWN IS A 5" DYNAMIC

The instrument has more tubes than is usual for such a device. The 6B8-G is in the probe.

A VERSATILE VTVM

This Small Instrument Measures Volts and Milliamperes

THE average serviceman or experimenter can build an electronic voltmeter which will be entirely satisfactory at a cost of less than ten dollars, plus a few hours of labor.

The conventional approach to electronic voltmeters has been to employ two tubes in a push-pull circuit to actually drive the meter. The reason given for this is that a push-pull circuit is needed to provide linear deflection of the meter. This is not true—or at least, does not have to be true.

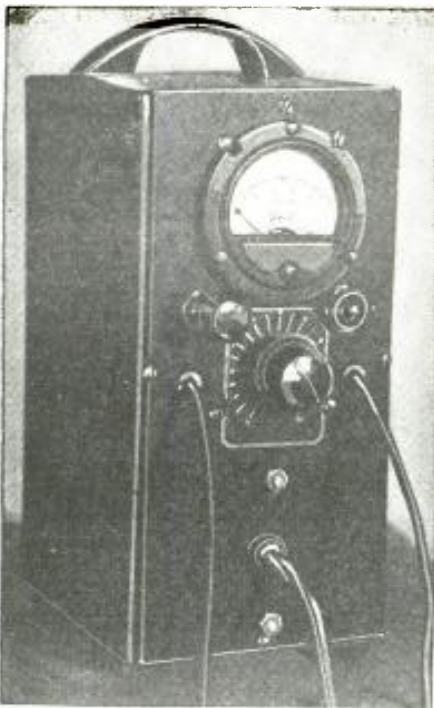

The line-operated portable volt-milliammeter.

Another current foible is that it is necessary to precede this push-pull stage with still another stage in order to get input resistances of reasonably high values. When a rectifier is added to this array of tubes, the total adds up to four—and some designers go a step further and put in a voltage regulator tube or even two of them!

One final pet peeve is the unvarying combination of electronic voltmeter with an ohmmeter. Most servicemen and experimenters have some sort of a universal meter with a satisfactory ohms scale. And two ohmmeters are as useful and necessary as three legs. But almost everyone has need from time to time of an extra current-reading meter. For instance, in reading the plate and grid current in an oscillator, or in balancing a push-pull stage by getting the current drawn by both tubes equal, two current

meters are needed. Accordingly it was decided to make this electronic voltmeter double as a multi-range milliammeter, and to forget about incorporating any resistance ranges in it.

The specifications tentatively set up called for the cheapest possible unit compatible with reasonable accuracy and with a high input resistance. The unit had to be sensitive, a.c. operated, and use the one-milliamper meter which happened to be available.

A little thought brought the conclusion that a high gm tube with a rectifier unit in the same envelope would do the job. The 117L7 was selected—mainly because it was available. The 117N7 would probably be a little better, though there is not much difference between the two. The 117L7 has a gm of 5300 and a plate resistance of about 17,000 ohms when operated with recommended voltages. The rectifier section will supply 75 milliamperes, which is ample for this purpose.

INPUT IMPEDANCE PROBLEMS

To get a high input resistance, it is necessary to do more than just insert 20 or 30 megohms in the grid circuit of the tube—especially of a so-called power tube. Under normal operating conditions the beam power amplifier section of the 117L7 should not have a resistance in its grid circuit greater than a half megohm—according to the tube manual. The reason for this is that some electrons en route to the plate do strike the grid and must be permitted to leak off without biasing the tube negatively an appreciable amount. If the number of electrons flowing from cathode to plate is reduced considerably, naturally there will be a corresponding reduction in the number that end up on the grid. For this reason it was decided to reduce the plate voltage applied to the tube from the normal 100 volts or so to about 30 volts. In addition to that, the heater voltage was reduced somewhat, to about 100 volts. It is inadvisable to reduce the heater voltage much more than that, since the rectifier half of the tube needs a reasonably normal heater voltage to supply the nominal 40 milliamperes drawn from it. Under these operating conditions it was found possible to insert a total of ten megohms in the grid circuit with no ill effects. With these circuit parameters the tube draws a little less than seven ma, with no signal voltage applied to the grid.

A little experiment showed that the tube—even with these reduced voltages—still had a fairly high gm. However, it was disappointingly non-linear. A portion of the characteristic curve which

was straight for two or three volts at moderate bias, was not to be found. The best portion of the curve seemed to lie near a bias point of 2.5 volts, and here only about a portion half a volt long was really linear. In other words, the current passed by the tube would increase in direct proportion to the voltage impressed on the grid only if the voltage impressed was limited to not much more than half a volt.

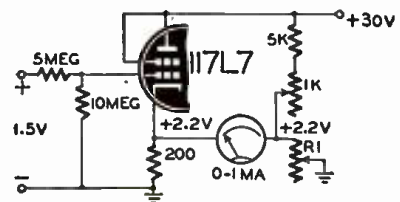
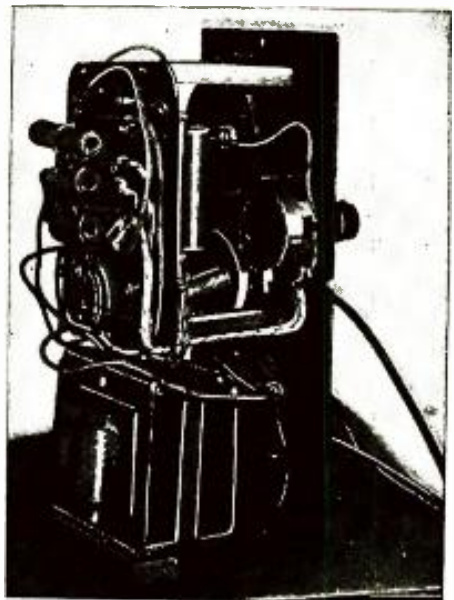

Fig. 1—First experimental voltmeter circuit.

The problem, then, reduced to finding a circuit which would permit applying as much as a volt across the input, yet would still result in linear operation. A cathode follower circuit is one in which the cathode voltage rises and falls in phase with grid voltage variations. With a cathode resistor of infinite size, it is theoretically possible to have the cathode go just as positive or negative as the grid does. In practice, an actual loss in voltage across the cathode resistor—as compared to the voltage from grid to ground—is to be expected. This circuit did offer the possibility of staying

(Continued on page 578)



This rear view shows how parts are mounted.

THE RCA ANTENNALYZER

Electronic means of designing directional antennas

CONSTRUCTION of directional radio antenna systems is a complex operation. To concentrate the power of a station in any given direction, from two to a half-dozen aerials may be required, each transmitting in such phase relation with each of the others that the signal may be reinforced in the desired direction and cancelled in all others. In certain special cases, odd-shaped patterns may be required, as when a station near an irregular seacoast may wish to cover three quadrants, but not waste power broadcasting over the fourth, occupied only by sea. In at least one other case, it was found desirable to avoid blanketing the local stations of a single city with the signals from a powerful broadcaster, while maintaining signal strength all round (and even beyond) it.

The march toward higher frequencies has accentuated the need for and increased the possibility of using directional antennas. As frequency is increased, it becomes more and more difficult to generate large amounts of power. The difficulties inherent in the construction of antenna systems, however, decrease as dimensions are reduced. An antenna system which, at broadcast frequencies, would cover several acres of ground and require tons of copper, may be mounted on a single light mast if the frequency is high enough.

Equations for the radiation patterns

$$\left\{ \begin{aligned} &+ M_B \cos \left(\alpha_B + \frac{2\pi d_B}{\lambda} \cos [\phi - \theta_B] \right) \\ &+ M_C \cos \left(\alpha_C + \frac{2\pi d_C}{\lambda} \cos [\phi - \theta_C] \right) \\ &+ M_D \cos \left(\alpha_D + \frac{2\pi d_D}{\lambda} \cos [\phi - \theta_D] \right) \\ &+ M_E \cos \left(\alpha_E + \frac{2\pi d_E}{\lambda} \cos [\phi - \theta_E] \right) \end{aligned} \right\}^2 \\ + \left\{ \begin{aligned} &+ M_B \sin \left(\alpha_B + \frac{2\pi d_B}{\lambda} \cos [\phi - \theta_B] \right) \\ &+ M_C \sin \left(\alpha_C + \frac{2\pi d_C}{\lambda} \cos [\phi - \theta_C] \right) \\ &+ M_D \sin \left(\alpha_D + \frac{2\pi d_D}{\lambda} \cos [\phi - \theta_D] \right) \\ &+ M_E \sin \left(\alpha_E + \frac{2\pi d_E}{\lambda} \cos [\phi - \theta_E] \right) \end{aligned} \right\}^2$$

The Antennalyzer obviates problems like this. of directional antenna systems are well known, but the arithmetical work necessary to secure the plot of a radiation pattern is tedious and time-consuming. It is not surprising that efforts have been made to do this work mechanically

and even electrically. As early as 1943 an electrical system for calculating the polar diagrams of systems with as many as five aerials was described (*Electrical Communications*, Vol. 21, No. 2, abstracted in *Radio-Craft* August, 1943). This was non-electronic in action, using a number of Selsyns fixed on a shaft, their phase position simulating that of the separate aerials in the antenna system studied. Rotating the whole group with the shaft is equivalent to taking measurements in a circle of azimuth around an actual antenna system, the "radiation pattern" being read on an a.c. voltmeter and plotted every few degrees around the circle.

ELECTRONIC MEANS SOUGHT

It was not surprising that engineers began to cast about for electronic means of handling these complicated calculations, only incomplete solutions of which could be approximated with earlier and cruder apparatus. The RCA Antennalyzer was developed to perform the major part of this work entirely by electrical means with no moving parts except the series of potentiometers which change the various parameters. Through its use, the time required to solve an antenna problem has been reduced from several days to a few hours. Fifty-two tubes are used to perform the various functions.

Developed specifically for the design of directional antennas for broadcast use, the Antennalyzer, in the form illustrated on the cover, will yield the radiation pattern of directional antennas which have as many as five towers or sources of radiation.

Each source is characterized by four parameters: 1, the distance from a reference point; 2, the azimuth angle with respect to a base line; 3, the amount of current in the antenna, and 4, the phase angle of this antenna current. Thus the Antennalyzer has four potentiometers associated with each antenna, with one exception. One antenna is located at the reference point and carries unit current at zero phase. Hence no controls are required with this antenna.

The radiation pattern is displayed directly on the face of the cathode-ray tube, either in polar or rectangular coordinates.

The Antenna may be used in two ways. The dials may be set to correspond to a given antenna configuration

after which the resulting pattern is observed on the C-R tube, or, when a given pattern is the goal, the dials may be twiddled until the proper pattern is obtained. Then the dial settings are recorded. These dial settings tell where to locate the powers, as well as the current ratios and phase angles to use. With a little practice, this operation may be performed in a few minutes. Metering devices are included in the Antennalyzer so that the ratio of maximum field intensity to r.m.s. field intensity is obtained.

One interesting point in connection with the use of the Antennalyzer was observed recently. After engineers familiar with the operation of the instrument had established the proper location for an antenna array, the final trace was marked with crayon on the C-R tube face. Then the controls were misadjusted and the Antennalyzer turned over to an engineer who had never used the device. In six minutes he had manipulated the dials until his trace on the oscilloscope coincided with the crayon markings. Checking his dial settings with those first recorded, it was found that he had arrived at an antenna arrangement which differed from the original. This can happen under certain circumstances. It has been found that when a rather complicated pattern is desired, where the use of three or more antennas are necessary, it is possible to find two or three configurations which yield the same pattern.

MEASURING ANTENNA GAIN

One of the uses of the Antennalyzer is in measuring the gain of a directional antenna system. When the designer has arrived at the proper pattern he usually desires a knowledge of the scale factor to place on the plot. An exact determination involves a knowledge of the mutual resistance existing between the antennas. However, an approximate answer may be obtained quickly by plotting the pattern in polar coordinates and measuring the area with a planimeter. A circle whose area is the same is then taken as the circle from a single antenna operated with the same power. The radius of this circle is the r.m.s. value of the horizontal polar diagram. This approximate relation may be obtained by measuring the peak value of the signal coming out of the Antennalyzer and then measuring the r.m.s.

(Continued on page 549)

FM CARRIER STABILIZATION

Part I—The General Electric and Federal Systems

ONE of the major problems in FM broadcasting has been that of maintaining the average carrier frequency while modulating it so that it deviates up to 75 kc on either side of its assigned value. The FCC regulations call for a maximum drift of only 2000 cycles from the mean, a very small percentage of the new FM carriers (which operate on approximately 100 mc).

Amplitude modulation broadcasting takes advantage of the precise unchanging carrier possible with crystal control. This property is a disadvantage in FM. The crystal resists the change of frequency which is the very basis of the system.

The major electronic and radio manufacturers have devised ingenious methods whereby the high standard of crystal control is combined with frequency modulation techniques so that the mean transmitted carrier is maintained within the rigid requirements while it deviates in accordance with the modulation to provide the very high fidelity of which the FM is capable.

GE PHASITRON METHOD

The type GL-2H21 phasitron tube (Fig 1) is designed to provide wide phase excursions at audio frequency rates in a crystal-controlled carrier. It

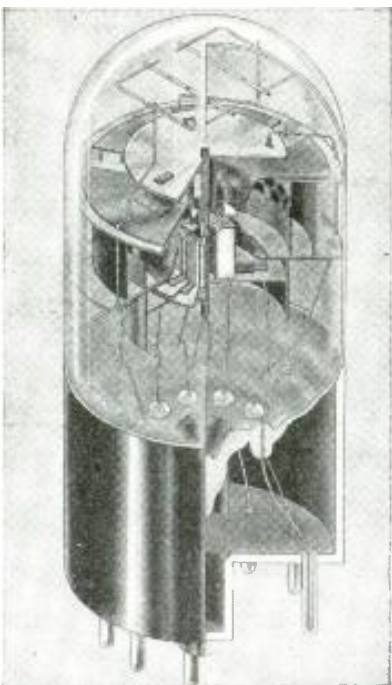

Fig. 1—The G-E Phasitron, structural view.

can operate up to 500 kc. It is generally used at approximately 230 kc, a frequency at which it permits a deviation of approximately 175 cycles per second. Multiplying these values by 432 puts the carrier in the new FM band with a

Construction of the deflecting grid system and its connection to the circuit are shown in Figs. 4 and 5. As a consequence of the 3-phase voltages, the potentials on grids A, B, and C vary. At some instant, for example, A and B are

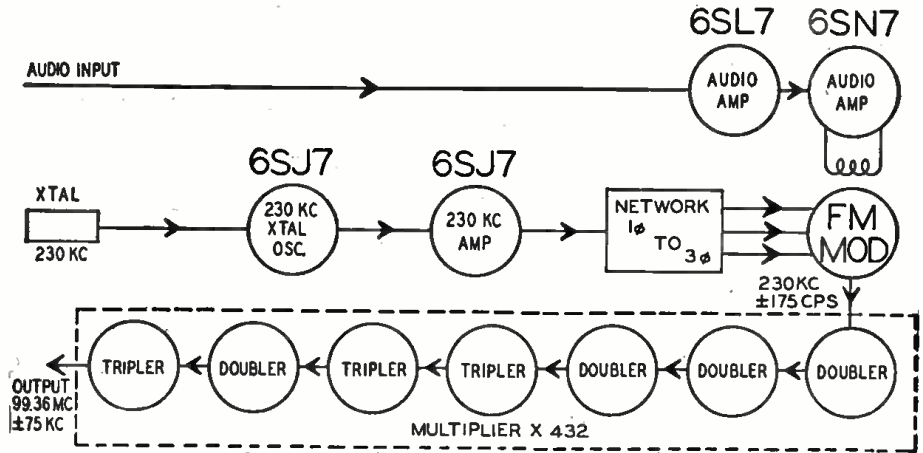

Fig. 2—Block diagram of the G-E FM circuit which uses the Phasitron frequency modulator.

maximum deviation of 75 kc as required.

The associated circuits required by the phasitron are not complicated. They consist essentially of a crystal oscillator operating at 230 kc and a circuit to convert the output to 3-phase 230 kc (Fig. 2).

The tube contains a deflecting grid structure of 36 wires, the active portions of which are horizontal. Every third wire is connected together and to a common base pin. Each phase of the 3-phase voltage is connected to one of these base pins. An additional deflector is connected to another base pin and constitutes the neutral plane (Fig. 3), and is grounded through a condenser.

Electrons emitted from the cathode are attracted to anodes 1 and 2 (Fig. 4), which are at positive potential, thus forming a tapered thin-edge disk. This electron disk extends from cathode to anode 1 and lies between the neutral plane and the system of wire deflectors.

positive and C negative (Fig. 3-a). The latter grids repel electrons towards the neutral plane, while A and B attract them. The periphery of the disk then assumes a sine wave pattern (Fig. 6) which rotates at a velocity determined by the crystal frequency and the number of deflector grids.

Anode 1 has 24 holes punched in it,

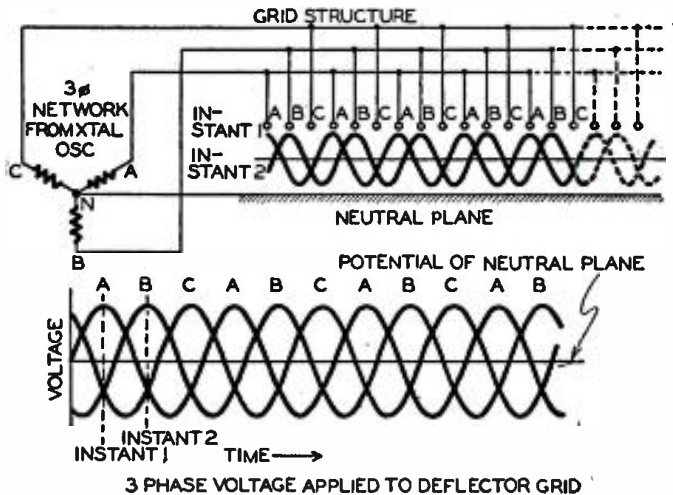

Fig. 3—Action of three-phase voltage in the deflector grid system.

12 above the disk plane and 12 below it. These are shown in Fig. 7. At the instant when the sine wave pattern is in the position shown by the heavy lines, all electrons are transmitted through

(Continued on following page)

(Continued from previous page)
 the holes to anode 2. One half-cycle later (dotted lines) no current can pass through the holes and anode 2 current is zero. As the disk rotates the anode current varies sinusoidally between these extremes.

To modulate this current a coil L is placed over the phasitron (Fig. 8). It is supplied with the audio frequency current. The magnetic force on each electron moving from the cathode causes the entire disk to rotate in a direction determined by the polarity of the a.f. voltage. This effect acts to speed up or slow down the electrons in the already-rotating disk. Therefore an angular displacement (at an audio rate) is superimposed upon the normal disk rotation due to the 230 kc, 3-phase voltage, and results in phase modulation of the carrier. A maximum a.f. power of 50 milliwatts is required.

FEDERAL'S FREQUENCY STABILIZATION

This CFS system is based upon the Miller effect principle, generally known to radio technicians as a difficulty to be overcome. In this case it is a useful property. As a result of Miller effect, the input capacitance of an amplifying tube depends upon its amplification and upon the difference of phase between a.c. grid and plate voltages.

The modulating unit (Fig. 9) is an important part of the circuit. It contains a Hartley coupled oscillator operating at approximately 4 mc. This frequency is divided by 256 in suitable multivibrator circuits so that it lies within the limits of 14.3-17.6 kc, depending upon assigned carrier. The frequency of a precise temperature-controlled crystal oscillator is similarly divided so that the frequency is the same as that just mentioned (Fig. 10).

The two frequencies so obtained differ in phase. They are passed through

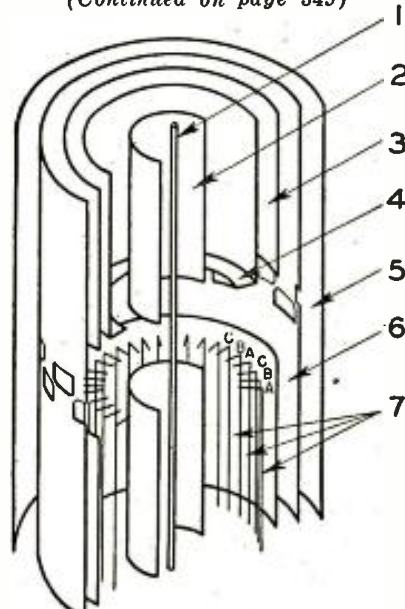

Fig. 4—Phasitron, cutaway view. 1—Cathode. 2—Focus electrode No. 1. 3—Focus electrode No. 2. 4—Neutral plane. 5—Anode No. 2. 6—Anode No. 1. 7—Deflector grid.

Fig. 5—How the Phasitron is connected to frequency-modulate the crystal's output.

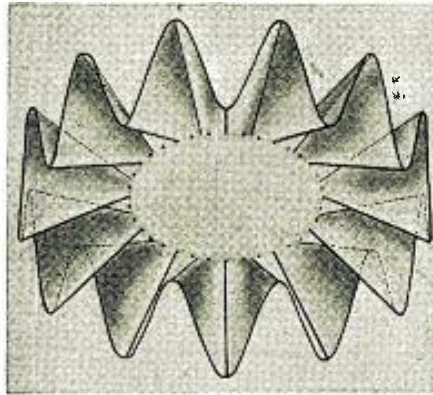
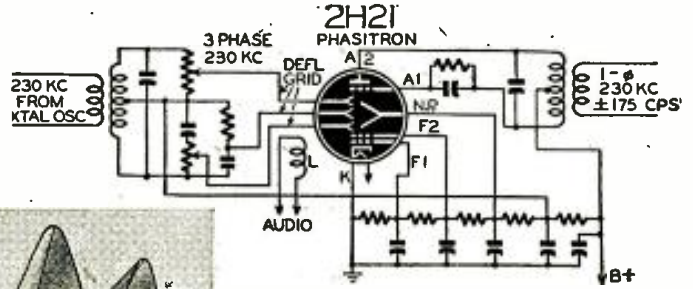

Fig. 6, left—Pattern of the rotating disk of electrons due to the three-phase voltage.

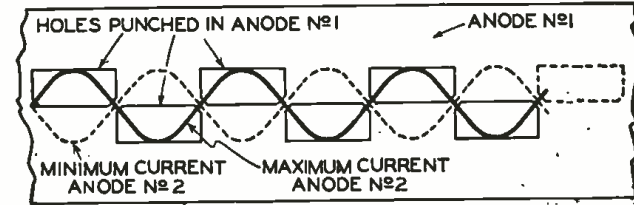

Fig. 7, left, below—Structure of Anode 1, showing maximum and minimum current curves.

Fig. 8, below—How audio-frequency modulation is impressed upon the Phasitron tube.

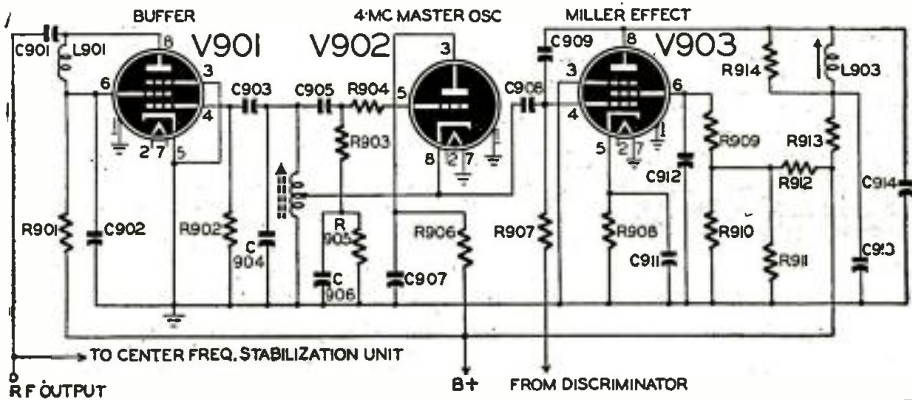
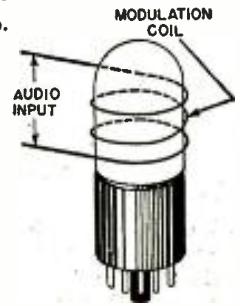

Fig. 9—The Federal system employs the well-known Miller effect to stabilize frequency.]

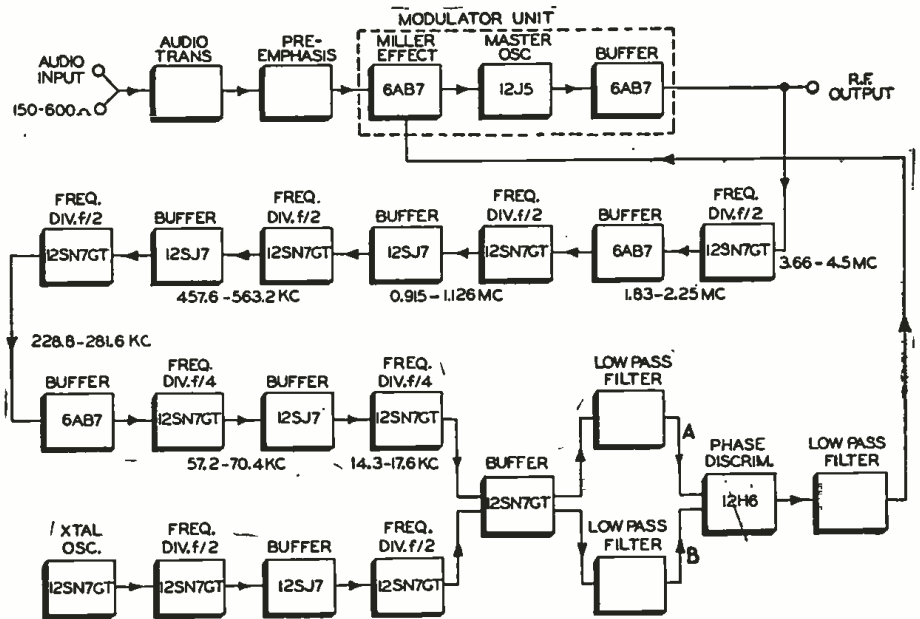

Fig. 10—Block diagram of the stabilizing unit, showing the frequency-dividing system.

SUPERAMP WITH TUNER

This High-Fidelity amplifier includes a radio receiver

THIS amplifier, an experimenter's consolidation of circuits, has satisfactory tone, volume, and a number of useful auxiliary features. The original model is constructed in a 10x8x10-inch sloping front, metal cabinet, and on a 9x2x7-inch chassis; an external speaker is used. Since wiring and components are close, all coupling condensers, A.F. leads, and other sensitive components were shielded thoroughly wherever possible. Output is about 20 watts.



A tuner, amplifier and turntable in one unit.

The circuit consists of: a superheterodyne tuner, a volume compressor-expander, a three-channel input with

mixers (plus tuner input channel) and a high gain push-pull amplifier.

A double triode-7F7 is used for a two-channel mike input, the grid leaks of each section forming volume controls for the microphones, thus serving as efficient mixers. The plates of the 7F7 are coupled together through a one-megohm resistor, reducing amplification but preventing any motorboating. From here, the a.f. signal travels through a switch on the back of one of the mike controls, through a coupling condenser to the center-tap of the phono volume control, the lower side of which is shunted with 50,000 ohms to ground.

COMPRESSOR-EXPANDER

The higher potential side of the phono control, from whence the signal comes, is fed through a coupling condenser to the grid of a 7A7, used in a volume expander-compressor circuit, with little amplification value. Also, the signal from the phono control is fed to the grid of a 7C7, which acts as an amplifier in the volume "expand-compress" circuit.

From the plate of the 7C7, the signal passes to one cathode (coupled to the opposite plate) of a double-diode rectifier 7A6. A center-tapped potentiometer is coupled between the other cathode and the opposite plate to it, with the center-tap grounded (See figure). As

the signal amplitude increases, so does the potential in the 7A6. The plate end of the expand-compress control will gain negative potential, while the cathode side will be positive, with respect to ground. By moving the control arm to the right or left of center, variable degrees of positive or negative rectified voltage will be applied as bias to the 7A7; this rectified voltage increases with signal amplitude, giving desired compressed or expanded signal from the 7A7 plate. Expansion of volume is used to increase the dynamic volume range of phonograph records which were compressed during the process of recording. Conversely, compression of volume is sometimes desired when using the amplifier for recording purposes.

Leaving the 7A7, the signal is amplified by a pentode-amplifier 7C7, then by a triode 7A4. Here an audio transformer is used as coupling to a pair of beam-power 6V6's or 6L6's, in push-pull. Inverse feedback is applied by a 5-megohm resistor in series with a blocking condenser between the grid and plate of each 6L6. Since B-plus leads were long, an 8-microfarad condenser was placed directly at the 6L6 screen grids.

An octode or pentode converter is used in the first stage of a superheterodyne tuner. The superhet was used because of space limitation, in this case.

(Continued on page 563)

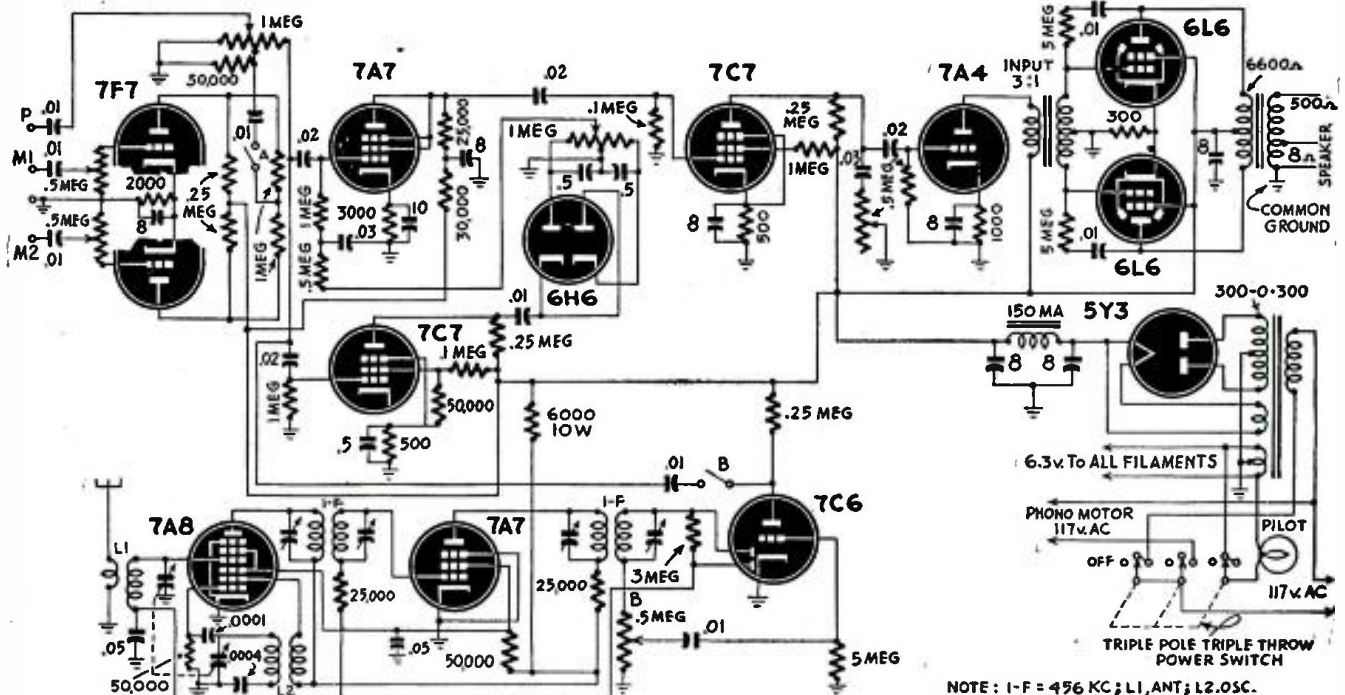

NOTE: I-F = 456 KC; L1, ANT; L2, OSC.

The Superamp comprises a high-fidelity amplifier and a superheterodyne tuner. There is a radio, phonograph and two microphone inputs.

VISUAL RADIO ALIGNMENT

With a "Wobbulator" and Oscilloscope

SOON the new post-war receivers will make their appearance in dealers' salesrooms throughout the country. Many of these models will incorporate FM, television, high fidelity audio and other refinements that the public expects in the post-war era. Shortly after these receivers find their way to the consumer, visual alignment must become a technique of great interest to servicemen who will have to service these new sets.

Visual alignment has been used little in the past. Many servicemen believe it to be radically different from the out-

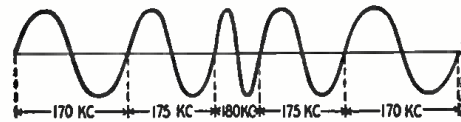

Fig. 1—The signal "wobbles" across the i.f.

put meter method. This is not the case.

Equipment necessary for visual alignment consists of the usual alignment tools (wands, wrenches, etc.), a cathode-ray oscilloscope, and a frequency-modulated signal generator. The first two items need little or no explanation. The last one, though by no means a recent innovation, has not been widely used in the servicing field and will bear some explanation.

A frequency-modulated signal generator is one whose output varies continuously in frequency above and below a given center frequency at a predetermined rate. For example, if the center frequency were 175 kc and the frequency deviation were ± 5 kc, the frequency of the output signal generator would vary continuously from 170 to

180 kc and back again from 180 to 170 kc, as shown in Fig. 1.

There are two general types of FM signal generators, or "wobblers" as they are sometimes called. One type employs a motor-driven rotating condenser and the other develops the signal electronically. The rotating-condenser variety has become almost obsolete, so little need be said about it. There are a number of ways in which an FM signal can be electronically produced. The most popular method is to apply a low frequency control signal (usually 60 cycles) to the grid of a reactance tube, causing the tube to act as a varying inductance across the oscillator tube.

A schematic diagram of a typical instrument of this type which is capable of operating at mean frequencies from 415 to 540 kc and band widths of 0-40 kc is shown in Fig. 2. In this circuit the 6J7 is the reactance tube and the 6K8 is both a mixer and FM oscillator, the triode section performing the latter function. The band width may be regulated by raising or lowering the amplitude of the 60-cycle input to the 6J7 grid by means of R1. Once this adjustment is made, the mean frequency is swept back and forth through this range at a definite linear rate of 60 cycles per second by the 6K7 sweep generator. The band width is kept constant by using a second external variable frequency oscillator whose output is not modulated, and combining the two signals in the pentode section of the 6K8 tube as in a standard superheterodyne. The result of combining a frequency modulated signal with an unmodulated r.f. signal is a third signal which is fre-



Born an electrician's son, Eugene J. Thompson early became interested in electrical subjects. Built his first radio while in high school, at the same time attending radio classes at night. Entered the College of the City of New York in 1939, majoring in science. Meanwhile repaired radios for spending money in his spare time.

Leaving college shortly after Pearl Harbor, Mr. Thompson enlisted as an Aviation Cadet, serving as navigator and instructor-in-charge of Radio Navigation and reaching the rank of first lieutenant. After leaving service held several engineering positions in war plants manufacturing electronic devices, also writing technical manuals for the Army and Navy.

Ambition: to become a psychiatrist—starting medical school this fall. Hobby (other than radio) photography. Member Delta Kappa Epsilon and the Caduceus Society. City College.

quency modulated and whose mean frequency is equal to the difference between the two original frequencies. A few examples will make this clear.

If we had a receiver with an i.f. of 175 kc and a pass band of ± 10 kc, assuming the mean frequency and frequency deviation of OSC. No. 1, which is the FM oscillator, were set at 460 kc and ± 10 kc respectively, by adjusting

(Continued on page 571)

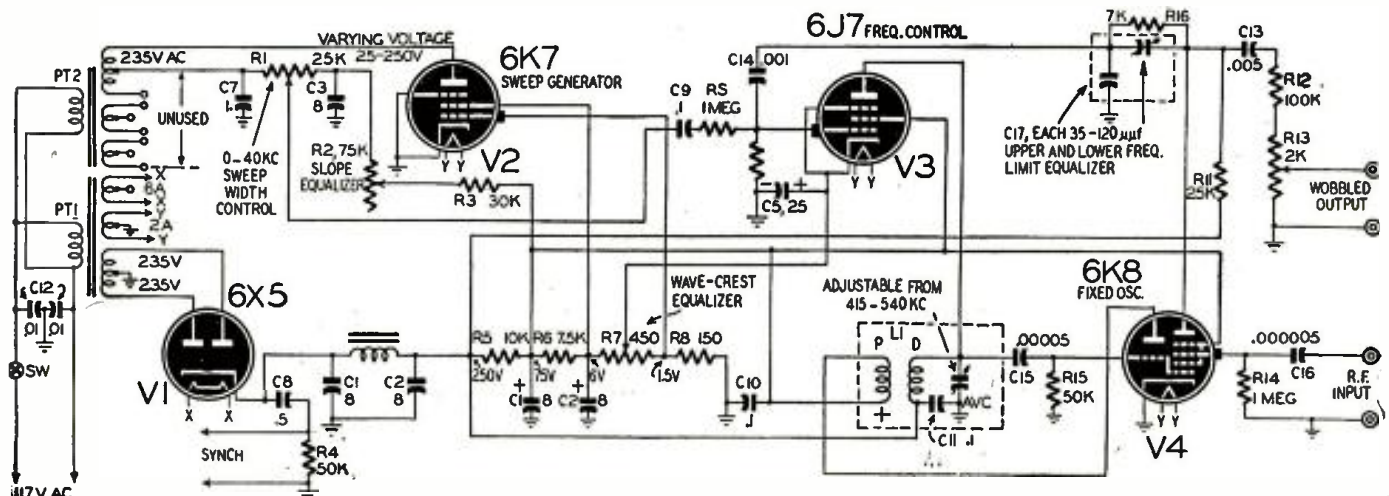

Fig. 2—Schematic diagram of a fully-electronic frequency-modulated signal generator or "wobbulator" as used for i.f. alignment.

CLAMPING CIRCUITS

The "D.C. Restorer" Is Applied in Many Radio Circuits

ANY wave form—regardless of shape or frequency—has a reference level of voltage about which recurrent alternations or changes take place. This axis is known also as the d.c. component of the wave. Its value can be established, changed, or reduced to zero by electronic action. However, when a wave form must be entirely above or entirely below a reference level, a process known as *clamping* is used.

A clamping circuit maintains either the positive extreme or the negative extreme of a wave form within the limits of a desired reference level of voltage.

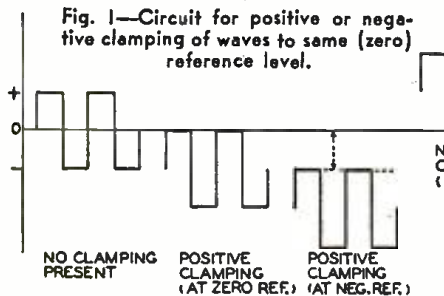

Clamping is not to be confused with limiting. A limiter introduces deliberate distortion whenever a wave form exceeds a certain voltage level. A clamping circuit shifts the axis of a wave form so that one of its amplitude extremities is not permitted to exceed a certain level of voltage.

There are two kinds of wave clamping (Fig. 1) according to the appearance of the desired result or output wave. *Positive clamping* means that the positive extremities of a wave are held to a certain reference level with respect to zero or ground. *Negative clamping* means that the negative extremities are held to a certain reference level.

In electronics work the most common reference axis is ground, or zero. Clamping is usually accomplished with respect to that reference.

In some radar, television, and industrial electronic circuits the reference level normally may be as much as several thousand volts, and either plus or minus in polarity. When such signal voltages pass through a coupling condenser at any point in the circuit, the d.c. component is lost. This is often undesirable.

However, the old reference level can be reestablished—or a new axis established—by the use of suitable clamping circuits.

Since a d.c. component is effectively restored by such circuits, they are sometimes called *d.c. restorers*. But this name

is misleading, because the actual d.c. component present in the output wave of a clamping circuit has nothing whatever to do with any d.c. component which may or may not be present in the original input (signal) wave.

Clamping circuits may be classified according to their electronic simplicity in three general categories:

- Diode Clamping,
- Grid or Triode Clamping,
- Synchronized Clamping.

The simplest clamping circuit (Fig. 2) consists of a series condenser C and a parallel resistor R, followed by a diode connected across the line.

When a non-sinusoidal but recurrent wave is applied to such a circuit, the axis of the original signal is shifted below ground so that positive-going extremities of the wave never appear above the zero reference level (ground). This is known as *positive clamping* with a diode.

Regardless of the shape or complexity of the input signal, when the recurrent wave form is applied to the condenser C the signal loses immediately any d.c. component which may have been present. The wave then assumes a new reference level with respect to ground—so that for any one recurrent cycle the area of the wave above ground and below ground is equal. In other words, the signal shifts in such a manner that the zero reference (ground) appears through the average center of the wave.

The input signal has suffered no change of phase or shape by this initial action. The wave merely has been shifted with respect to a new reference level: ground, or zero.

The wave is then applied directly to the actual clamping circuit.

Condenser C is charged and discharged by the input signal at a rate dependent upon (1) the recurrent frequency of the input wave, (2) the value of the condenser, and (3) the value of the resistance in the circuit.

Values of the condenser C and resistor R are selected so that their product (RC) provides a long time constant,

with respect to the frequency of the input signal. Effect of a long time constant on the input is negligible—under usual operating conditions. But the clamping circuit contains a diode, whose action must also be considered.

Conduction takes place in a diode only when the plate is positive with respect to the cathode, or the cathode is negative with respect to the plate. In the circuit of Fig. 2, the diode can conduct only when its plate is positive with respect to ground.

When no input signal is present, there is no conduction, but when the signal is applied, the following transient effect immediately takes place:

On all positive portions of the input wave, the diode conducts and effectively shunts out the resistor R. This action results in an effective short time constant. And the condenser C charges at a fairly fast rate.

On all negative portions of the input wave, the diode does not conduct. The circuit provides a long time constant for the much slower discharge of condenser C. The signal during negative portions is unaffected by action of the circuit. This uneven action—considerable charge, but much slower discharge of condenser C—continues for several cycles, until a charge has been built up on condenser C sufficient to shift the signal wave form below the zero axis. This uneven action is shown in Fig. 3A.

Such a transient effect takes place when a signal is first applied to the clamping circuit. Thereafter, the condenser remains charged and the output

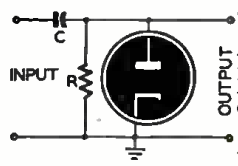

Fig. 2—Positive diode clamping to zero reference level. The signal during negative portions is unaffected by action of the circuit. This uneven action—considerable charge, but much slower discharge of condenser C—continues for several cycles, until a charge has been built up on condenser C sufficient to shift the signal wave form below the zero axis. This uneven action is shown in Fig. 3A.

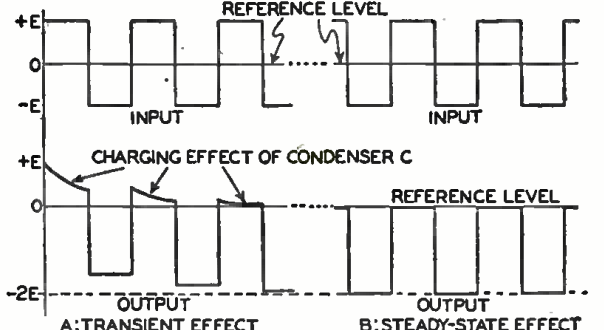

Fig. 3—Action of positive clamping circuit shown in Fig. 2, with transient and steady-state effects.

wave form is maintained so that positive extremities do not exceed the zero reference level. This steady-state effect (Continued on following page)

(Fig. 3B) continues until the input is changed or interrupted.

Care must be taken in the selection of values of R and C, to obtain a sufficiently long time constant. Actual values will, of course, depend upon the recurrent frequency of the input wave form.

In practice, the load resistance of the stage immediately following the diode

is approximately equal to the fixed voltage E (Fig. 4).

Occasionally a wave form is required to be clamped *above* the zero reference level. When the *negative extremities* of a wave's amplitude are held at or above the zero axis, the process is known as *negative clamping*, accomplished merely by reversing the diode connections.

In the circuit of Fig. 5, values of the condenser C and resistor R are again selected so that their product (RC) provides a long time constant, with respect to the frequency of the input signal.

The diode conducts only on negative portions of the input wave, thus shunting out the resistor R. The condenser C charges fairly quickly through the resultant *effective* short time constant.

During positive portions of the input wave the diode does not conduct, and the condenser C discharges only a small amount. The circuit presents a long time constant to the input, and the signal is relatively unaffected.

Since the rate of charge of the condenser C is greater than the rate of discharge, the axis of the output wave is shifted upward (in a positive direction)

so that the negative extremities of the wave are above the zero reference level. This process is known as *negative clamping*.

As previously, the output reference level can be established at some positive value above the zero axis. Circuit for this type of negative clamping is shown in Fig. 6.

A fixed voltage E is inserted in the plate lead of the parallel diode, re-

sulting in negative clamping of the input signal at a *positive* reference level. Value of the reference axis is approximately equal to the fixed voltage E (Fig. 6).

Clamping can also be accomplished with a triode or pentode—using the grid and cathode electrodes of such

tubes. This method of clamping is known as *grid clamping*. When a triode is used, this method is also known as *triode clamping*. If any element of a vacuum tube is made positive with respect to the cathode, electrons are attracted and there is a flow of current. Conversely, any element made negative with respect to the cathode repels electrons and there is no current flow.

Thus the grid and cathode electrodes of a triode, tetrode, or pentode could be substituted for the conventional diode in the clamping circuits discussed previously. But it is more usual to employ a triode for this purpose.

A typical grid clamping circuit is shown in Fig. 7, which supplies positive clamping. The triode is biased almost to the point of grid-current flow, and there is a resultant large plate current in the load resistance. Values of the condenser C and resistor R are selected so that their product (RC) provides a long time constant with respect to the frequency of the input wave form.

During positive portions of the input signal, the grid of the triode is driven positive and grid current flows. The circuit thus has an *effective* short time constant. And the condenser C quickly charges to the applied potential.

During negative portions of the input signal, the circuit presents a long time constant, and the input wave passes unaffected through the triode.

But the charge on condenser C is sufficient to shift the axis of the input wave form so that the positive extremities are below the reference level for positive clamping.

Reversal of the grid and cathode connections of the triode permits negative clamping in much the same manner.

CLAMPING CIRCUIT APPLICATIONS

Diode clamping and grid clamping are widely employed in radar and television, and to some extent in industrial electronics equipment. These types of clamping circuits find particular use in connection with cathode-ray tubes.

When a signal of any type is to be displayed on an oscilloscope, it is usually necessary to display the wave form with respect to some reference level—at, above, or below the scope's normal base line or zero reference. Normally such a signal would be coupled from the final output stage to the deflecting plates of the scope through a condenser, to pre-

(Continued on page 560)

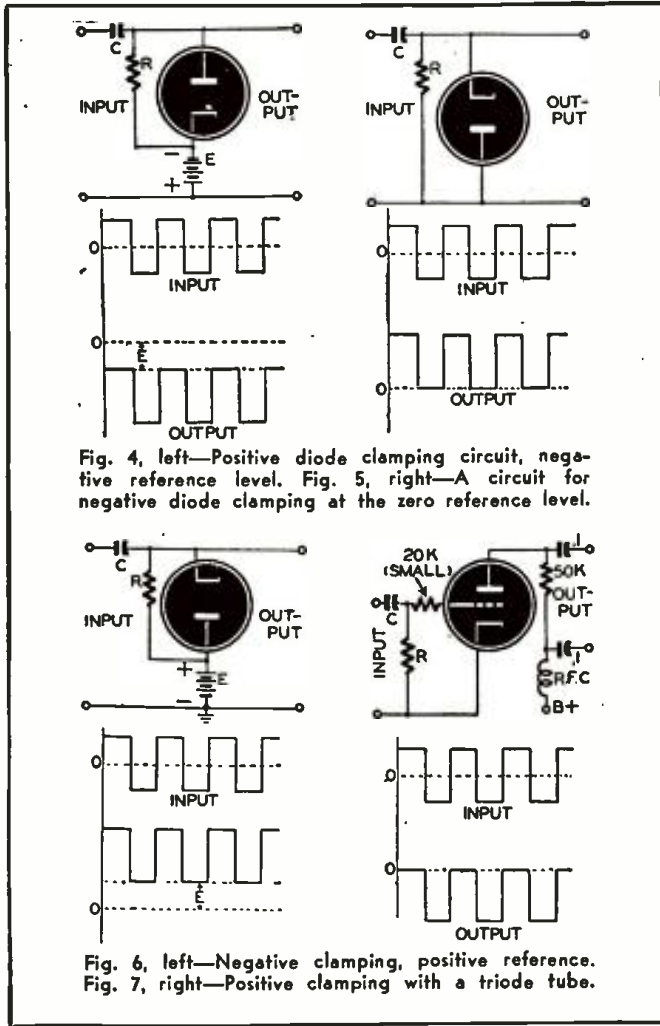

Fig. 4, left—Positive diode clamping circuit, negative reference level. Fig. 5, right—A circuit for negative diode clamping at the zero reference level.

Fig. 6, left—Negative clamping, positive reference. Fig. 7, right—Positive clamping with a triode tube.

clamping circuit often causes some slight discharge of the condenser during non-conducting portions of the input cycle. This results in a slight extension of the positive-going output wave *above* the zero reference level—instead of just touching it. This condition may be rectified—as described below—by applying a small bias voltage to the diode vacuum tube.

CIRCUIT VARIATIONS

Clamping of the positive extremities of a wave is not restricted to the zero reference level. Positive clamping usually takes place with respect to some fixed voltage *below* ground.

For this purpose a slightly different clamping circuit is used (Fig. 4.)

A fixed voltage E is inserted in the cathode lead of the parallel diode. Circuit operation is similar to the previous, unbiased diode clamping circuit. But the voltage E is additive to the positive reference level. This results in positive clamping of the input signal at a *negative* reference level, the value of which

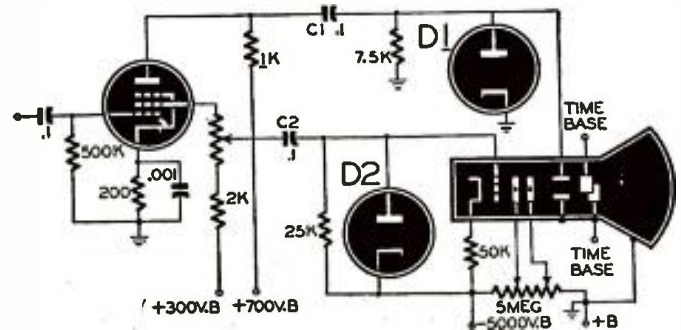

Fig. 8—Typical radar indicator circuit with two clamping diodes.

LOGIC—A REPAIR TOOL

Common Sense Is an Important Piece of Test Equipment

THE approach to the problems of radio servicing has been the focal point of much argument, and has given rise to the development of several conflicting schools of thought.

The best approach, the *logical approach*, one both rapid in employment and thorough in its revelations—this is the goal the several schools of thought pursue, each in its own way a different means to the same end.

What will be the approach? What the procedure: direct voltage and resistance measurements, channel substitution and section testing, or signal tracing? Every serviceman must face this question. He may choose one, two in combination, even all three. All three approaches have been proved to be efficient and successful. The analytical mind may choose signal tracing, the mind excelling in deductive and inductive reasoning may choose channel substitution, the mind more impressed by visual demonstration than by abstract thinking will prefer the direct measurements approach. Let us examine each method individually.

DIRECT MEASUREMENT

As implied by its name, this is the most *direct* approach to servicing. It does not necessarily follow, however, that it is the fastest method, or even the most efficient. It involves the discovery of disorders through abnormal or *sub-*

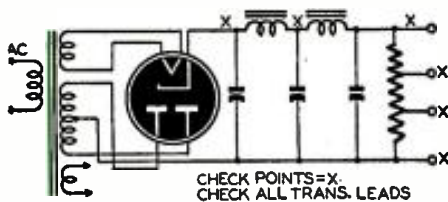

Fig. 1—Check points in receiver power pack.

normal voltages, currents, and resistances; lack of these indications where they should be found; or their presence where they should not be.

The protagonist of this method values his volt-ohm-milliammeter more than any other single item of test equipment. The direct measurements approach is the one which requires the least amount of test apparatus. A good multitester (one with a high ohms-per-volt rating, or preferably a vacuum-tube voltmeter) is the prime instrument required.

To the exponent of the direct measurements approach, the power supply and its leads are the heart and nervous system of the radio. He will therefore begin by making inquiries into the power supply. If voltage is present and normal

at the output of the power unit, he will consider this portion of the receiver in good order. If he does not find the voltage output of the power unit normal in every respect, he will make further measurements to determine which individual component within the power unit is at fault. He will take voltage readings along several points on the bleeder resistor or voltage divider, to measure the voltage between the various filter sections in search of shorted or leaky

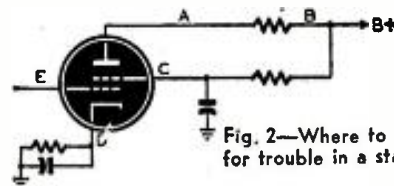

Fig. 2—Where to look for trouble in a stage.

filter condensers or open chokes and check the voltage at the rectifier cathode to determine if this tube is functioning properly. Once satisfied that it is, he will check the a.c. voltages on both sides of the power transformer.

The checkpoints in a simple and typical power supply are shown in Fig. 1.

The "direct measurements" serviceman will then proceed to measure all the individual plate, screen grid, control grid, and cathode voltages in the receiver. These checkpoints, designated by the letters A, B, C, D, and E are shown in Fig. 2. The presence of heater voltage can be determined by the "finger test" for metal tubes, or by visual observation in the case of glass tubes.

He will determine whether plate voltage is normal, too high, too low, or not present at all. Should a check at point A in Fig. 2 fail to indicate the presence of any voltage, this serviceman will check point B. A voltage reading at this point would be a definite indication that the plate-load resistor is open. If there is no voltage at point B, the lead between this point and the power supply is making bad contact.

A subnormal voltage indication at point A marks excessive plate current and would suggest such troubles as: Plate-load resistor increased in value, or bias-voltage decreased or removed entirely because of shorted or partially shorted cathode resistor or cathode by-pass condenser.

If the voltage reading at point A is too high, the plate is drawing too little or no current at all. This would again point to possible trouble in the bias system. Suppose the voltage at point A is roughly the same as the voltage at point B, and it has been determined that

the plate-load resistor is not shorted. Such a condition would indicate the complete absence of plate current, and the most logical conclusion is that the cathode circuit is open. A less likely reason is that the tube is biased beyond cut-off because of a disorder in the bias voltage.

An other-than-normal voltage reading at point C may indicate open leads or bad connections from the voltage source; shorted, open, or changed value of screen resistor; or shorted or leaky screen or cathode by-pass condenser.

This disregards the possibilities of shorts or opens within the tube best verified with a tube checker. Too high or too low a voltage at point D in Fig. 2, is again due to either excessive or insufficient plate current.

Consider the case of an open cathode resistor. Place the voltmeter probe on point D and a voltage is indicated. This will usually be higher than normally expected. The reason for any voltage indication at all at point D is that the voltmeter resistance has shunted the open cathode resistor and thus completed the circuit.

What of point E in Fig. 2? Unless there is some circuit arrangement to provide grid bias at this point, no d.c. voltage should be indicated. A sensitive a.c. voltmeter may be used to indicate the presence of excitation voltage at that point.

ADDITIONAL MEASUREMENTS

The direct measurements serviceman, finding the tube socket voltages normal, will then measure the a.v.c. voltage to determine if this circuit is operating. He will check for voltage on the local oscillator grid as an indication of oscillation.

If all voltages in the set are normal and the trouble has not been located, he will then turn the power off and proceed with resistance measurements, checking for continuity through all the coils and

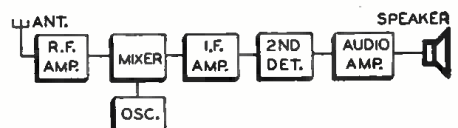

Fig. 3—Another way of viewing the receiver.

transformers of the set, all ground returns to the chassis, the voice coil of the speaker, and the contact arms on the rotors of the tuning condensers. He will check the values of vital resistances throughout the set. Resistance measure-

(Continued on page 574)

WORLD-WIDE STATION LIST

AS this goes to press we are waiting for the few more days before the 80-meter ham band is again opened to U. S. amateurs. We are looking forward to some very good QSO's with several of our friends of the old days. For some time now we have been playing around with the ten-meter band, but results on this band have not been what they were expected to be. Several good days have been experienced but they were few and far between. It is hoped that 80 meters

will be much better. Reports on reception on this band will be most welcome. Short wave reception has been rather erratic for some time, and only occasionally have any good dx catches been made. ZAA in Albania has been heard at 2 to 3:30 pm on 7.850 megacycles. This station is quite weak, but comes in occasionally with fair volume. VLR2 is heard well at 8 am on 6.150 megacycles, with the news in English. Sign-off time is 8:25 am. ZNS2 in the Bahamas is heard with the news at 8 am

on 6.090 megacycles. This transmitter is also heard at 5 to 10 pm on the same frequency.

CKNC is now broadcasting on 17.82 megacycles from 7 am to 1:30 pm daily. CKCX is heard from 7 am to 2:45 pm on 15.19 megacycles. CHOL is heard from 1:45 to 7 pm on 11.72 megacycles; and CKLO from 2:45 to 7 pm on 9.63 megacycles. These are all heard with very good results in all parts of the country.

All schedules are Eastern Standard Time.

Freq.	Station	Location and Schedule	Freq.	Station	Location and Schedule	Freq.	Station	Location and Schedule
7.320	GRJ	LONDON, ENGLAND: 6 to 10:30 pm; 11 pm to midnight.	9.130	H12G	CIUDAD TRUJILLO, DOMINICAN REPUBLIC: heard at 9 pm.	9.480		MOSCOW, U.S.S.R.: 6 to 8 am; 11 to 11:30 am; midnight to 1 am.
7.360	HET3	BERNE, SWITZERLAND: 6:30 to 8 pm.	9.140	KU5Q	GUAM: heard at 7 am.	9.490	WCBX	NEW YORK CITY: Brazilian beam. 4 to 10:30 pm.
7.380	NCN	U.S. Navy at Guam	9.165	CR6RB	BENGUELA, ANGOLA: 3:30 to 4:30 pm; 9:30 to 9 pm.	9.490	KNBI	SAN FRANCISCO, CALIF.: Oriental beam, midnight to 3:45 am; Hawaiian beam, 4 to 9:45 am.
7.380	HEK3	BERNE, SWITZERLAND: 10 am to 12:30 pm; 3:15 to 3:30 pm; 8:30 to 10 pm.	9.185	HEF4	BERNE, SWITZERLAND: North American beam, 7:15 to 7:45 am; 4:20 to 5:20 pm; 6:30 to 8 pm; 8:30 to 10 pm.	9.490	KNBX	SAN FRANCISCO, CALIF.: Oriental beam, 11:15 am to 3:30 pm.
7.565	KNBA	SAN FRANCISCO, CALIF.: Oriental beam, 4 to 9:45 am.	9.235	COBQ	HAVANA, CUBA: 8 am to noon; 8 to 10 pm.	9.490	GWF	LONDON, ENGLAND.
7.565	WNRE	NEW YORK CITY: European beam, midnight to 3:15 am; 4:30 to 6 pm.	9.270	COCX	HAVANA, CUBA: heard at 12 am.	9.495	ZBW	VICTORIA, HONG KONG: 4:30 to 8:30 am.
7.570	EAJ43	SANTA CRUZ, CANARY ISLANDS: 11 am to noon; 5 to 6:15 pm.	9.300	KU5Q	MACEIO, BRAZIL: 6 to 7 pm.	9.500	XEWU	MEXICO CITY, MEXICO: 8 am to 2 am.
7.575	KCBA	SAN FRANCISCO, CALIF.: East Indies beam, 4 to 9:45 am.	9.330	KU5Q	GUAM: 8 am.	9.502	OIX2	LAHTI, FINLAND: 7:15 to 7:45 pm; 11 to 11:30 pm.
7.805	KNBX	SAN FRANCISCO, CALIF.: Oriental beam, 5 to 11:00 am.	9.340	PIY9	ANDORRA: noon to 7 pm.	9.510	TAP	MANILA, PHILIPPINES: 5 to 7 am; 11 to 11:30 pm.
7.805	W00C	NEW YORK CITY: European beam, midnight to 3:15 am; 3:30 to 5:45 pm.	9.345	HBL	WILLEMSTED, CURACAO.	9.510	GSB	GENEVA, SWITZERLAND: 1 to 3 pm.
7.850	ZAA	TIRANA, ALBANIA: English at 3 to 3:20 pm.	9.350		VIENNA, AUSTRIA: heard at 4:30 pm.	9.520		PARIS, FRANCE: North American beam, 12:30 to 12:45 am; 1 to 1:15 am.
7.860	SUX	CAIRO, EGYPT: 5 to 5:30 pm.	9.350	CBFX	SOFIA, BULGARIA: on to 11 pm.	9.520	VLW7	PERTH, AUSTRALIA: 5:30 to 10:30 am.
7.950		ALICANTE, SPAIN: off at 6 pm.	9.360		MONTREAL, CANADA: 6:30 am to 10:30 pm.	9.520	ZRG	JOHANNESBURG, SOUTH AFRICA: 3 to 7 am.
8.000		DAMASCUS, SYRIA: 11 pm to midnight.	9.360		CETINJE, YUGOSLAVIA: 1:30 to 3 pm.	9.525	GWJ	LONDON, ENGLAND: Near and Middle East beams, 11:45 pm to 12 am; 3:30 to 4 pm; African beam, 3:30 to 4 pm; European beam, 11:30 pm to 1:45 am; 5 to 8 am; 10:15 am to 11:30 am; 12 to 4 pm.
8.030	FXE	BEIRUT, LEBANON: 11 pm to 5:30 am.	9.370	EAQ	MADRID, SPAIN: 2 to 3 am; 7 to 9 am; 10 am to 5 pm; 6:30 to 9 pm.	9.530	WGEO	SCHENECTADY, NEW YORK: South American beam, 5 to 11 pm.
8.565	AFN	MUNICH, GERMANY: 4 am to 12:15 pm.	9.380	COBC	HAVANA, CUBA: heard at 5:30 pm.	9.535	JZI	TOKYO, JAPAN: 7 to 8:15 am.
8.665	COJK	CAMAGUEY, CUBA: 8 pm to 12:30 am.	9.385	OTC	LEOPOLDVILLE, BELGIAN CONGO: 5:30 to 7:30 pm.	9.535	SBU	STOCKHOLM, SWEDEN: 1:30 to 7 pm; 8 to 9 pm; Sundays only 5 to 9 am.
8.696	COCQ	HAVANA, CUBA: 7 am to 11:30 pm.	9.410	GRI	LONDON, ENGLAND: African beam, 12:30 to 2:30 am; 5:30 to 7:45 am; 10:30 am to 1 pm; 2:30 to 5:30 pm; European beam, 12:30 to 2:45 pm; 5 to 7:45 am; 10:15 am to 4 pm; 4:30 to 5:30 pm.	9.535		BERNE, SWITZERLAND: to North America at 8:30 to 10 pm.
8.840		HAVANA, CUBA: 4:30 am to 12:30 am.	9.420		BELGRADE, YUGOSLAVIA: midnight to 2 am; 10 to 10:45 am.	9.540	VLG2	MELBOURNE, AUSTRALIA: Asiatic beam, 7 to 9 am.
8.950	CDKG	DAKAR, FRENCH WEST AFRICA: afternoons 11:11 4:30 pm.	9.440	FZI	BRAZAVILLE, FRENCH EQUATORIAL AFRICA: 11 am to 8 pm; midnight to 2:30 am.	9.540	VLC5	SHEPPARTON, AUSTRALIA: North American beam, 7 to 7:45 am; 8:45 to 9:45 pm.
9.030	COBZ	SANTIAGO, CUBA: 6:30 am to 10 pm.	9.465	TAP	ANKARA, TURKEY: 11 am to 4:45 pm.	9.540	XERQ	PARIS, FRANCE: midnight to 12:15 am; 12:30 to 12:45 am; 1 to 1:15 am.
9.082	CNR3	HAVANA, CUBA: evenings.	9.470	CR6RA	LOUANDA, ANGOLA: heard signing off at 4:30 pm.	9.540	LKJ	MEXICO CITY, MEXICO: evenings.
9.120		HAVANA, CUBA: 7 am to 11 pm.				9.540	CJCA	OSLO, NORWAY: 2 to 2:30 am; 4:45 to 7 am.
9.125	HAT4	RABAT, MOROCCO: 2 to 5 pm. midnight to 3 am.				9.548	GWB	EDMONTON, CANADA: 9:30 am to 11 pm.
		BUKRAPAN, BORNEO: heard 5 to 6 pm.				9.548	OLR3A	SINGAPORE, MALAYA: 8 to 9:30 am.
		BUDAPEST, HUNGARY.				9.550		LONDON, ENGLAND.
						9.550	KGEI	PRAGUE, CZECHOSLOVAKIA: 3 to 6 pm.



"But I tell you—I hid \$150 in my radio!"

(Continued on page 550)

A U.H.F. HAM TRANSCEIVER

A Practical Unit for the 420-and-up Amateur Band

WITH activity starting to boom on frequencies higher than 400 mc, we decided a short time ago to construct and experiment with a compact, low-power transceiver which would operate at these frequencies. A portion of the amateur band in this range (420-430) has recently been made available. The remainder, comprising 430-450 mc, will probably be opened very shortly, giving the amateur 30 whole megacycles with which to experiment in a desirable part of the spectrum. The new citizens' band, from 460-470 mc, should also be opened soon. This, for the first time, will make radio reception and transmission legal without any license of any kind. This transceiver covers a range of 415-500 mc, including all the above.

Not much thought had to be given to choice of tubes, as the field is pretty well limited to the well-known and popular 955 acorn type. The small size fits well with the compactness of other components at ultra high frequencies and the low power requirements make it possible to run it efficiently from the a.c. line or from medium-sized batteries.

The complete set, except for speaker or mike and power supply, can be built in a space less than 4 x 4 x 4 inches. This is the size of our unit but the photograph shows unused space within this volume. It is possible, for example, to incorporate a small 2-inch PM speaker or small "B" batteries for the plates.

We were more interested in getting a solid, clear signal out of the antenna and this has been accomplished. Vibration and movement of the transceiver during transmission has no adverse effect on the signal and the frequency once set remains constant. There is no evidence of hand capacity during tuning. This instrument is definitely not a toy and the design has not been limited for the sake of compactness.

Experiments carried on over short distances within the same block show that the waves pass readily through partitions and brick walls. Communication over short distances did not require the receiver to be equipped with antenna. Our experiments show that with no benefit of location a mile or so can be covered. Given the advantage of height the signals should go the line-of-sight limit with a reasonably good signal.

R.F. SECTION

The circuit is a parallel-line affair but with condenser tuning for convenience and ease of calibration. The lines are ¼-inch copper tubing, each 2 inches

long and separated by about ⅞ inch. The miniature 50 µf condenser is connected across the far ends of the lines. The tube ends connect directly to the tube contacts.

Polystyrene blocks are used to insulate and support the r.f. components. The presence of this material has no appreciable effect on the r.f. fields, and though expensive, it is well worth-while. Leads between the r.f. and audio circuits go through holes drilled through the polystyrene. The material machines very well, taking saw, drill or tap very nicely.

The plate, grid and cathode circuits must be well isolated from other circuits by suitable r.f. chokes. We wired up a number of these experimentally, taking off turns until we arrived at an optimum in each case. Quite a bit of power can be lost through inefficient or insufficient chokes.

The tuned circuit is set back about

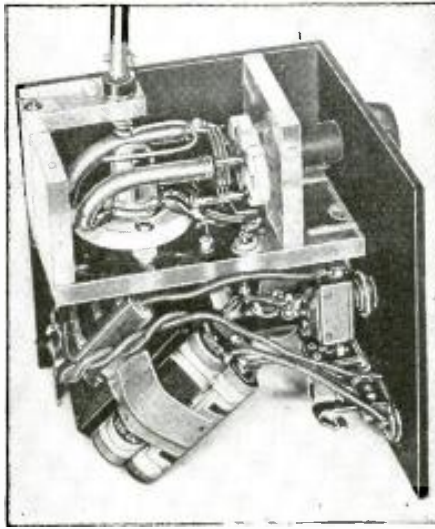

Top—The oscillator circuit. Heavy tubes are "long lines" and bent wire is antenna coupling. Below—Audio section. Batteries strapped to the transformer are to excite the carbon microphone.

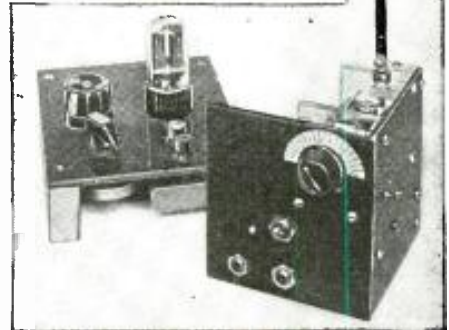
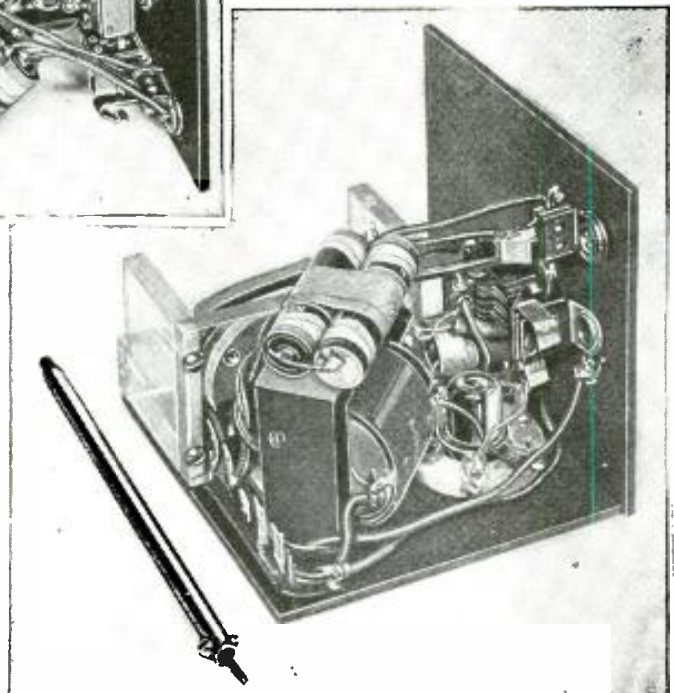

The transceiver with power pack (in rear).

1½ inches from the front panel. This effectively eliminates capacitance effects, which we feared at first. The metal shaft of the variable tuning condenser is extended by means of an insulated coupling and a short length of polystyrene rod. The front panel will accommodate a 2-inch dial but we were unable to locate one in Radio Row and had to be content to make a home-made job. This was done by pasting a circular piece of paper with inked divisions on the panel and using a small bakelite arrow knob.

POWER OUTPUT VS. FREQUENCY

As might be expected, the output is appreciably greater at the lower frequencies. Even the acorn tube begins
(Continued on page 585)

RADIO-ELECTRONIC CIRCUITS

SIGNAL GENERATOR

A few parts from the junk box may be assembled into an efficient signal generator in a short time. This will furnish either modulated or unmodulated r.f. signals at the will of the operator.

The circuit uses a 1G6-GT twin triode as radio and audio frequency oscillators. The grid coil of the r.f. oscillator

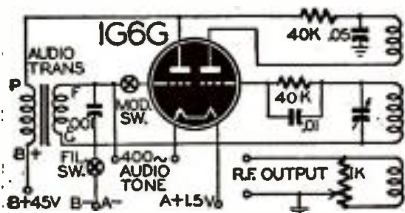

is wound with No. 32 enameled wire, close wound, to cover 1 1/2 inches on a 1-inch form and is tuned by one section of a standard broadcast condenser. This winding is then covered with a thin sheet of celluloid. The plate winding is wound over the lower end of the grid coil and covers 3/16-inch. The output coil is wound immediately above the plate coil and covers 1/2-inch winding space.

The modulator uses a straightforward audio oscillator circuit. The transformer is one designed for inter-stage coupling. A transformer with a 3-1 turns ratio is applicable to this circuit.

The panel controls are: TUNING, OFF-TONE-R.F., and ATTENUATOR. The dial used on the tuning condenser should be free from back-lash and capable of close calibration. The OFF-TONE-R.F. control is a double pole, three position switch. Variable r.f. output is possible through the use of a 1,000-ohm potentiometer across the output winding of the r.f. circuit.

The plate voltage is supplied by a small "B" battery of the hearing aid type and the filament voltage is supplied by a flashlight cell.

If either of the oscillators fail to oscillate, it may be necessary to reverse the connections of either of the windings.

This signal generator produces a signal from 400 to 1500 kilocycles and is useful in servicing broadcast receivers.

A. SKITSKI,
Waskatenau, Alberta

UNIQUE OSCILLATOR

A unique oscillator circuit using two separate triodes or a dual triode tube is illustrated in Fig. 1. A 6SN7-GT or a pair of 6J5 tubes are suitable. This oscillator will perform at radio or audio frequencies, depending upon the circuit constants. The simplicity of the tuned

circuit makes this oscillator easily adaptable for multi-band use.

A practical adaptation of the circuit is shown in Fig. 2. Here it is used as an audio-frequency signal generator. The coil L1, and capacitors C1, C2, C3 and C4 are chosen by experiment or calculation. Selector switch S1 is used to

Radio-Craft wants original kinks from its readers, and will award a seven-month subscription for each one published. To be accepted, ideas must be new and useful. Send your pet short-cut or new idea in today!

select any of the desired frequencies which are determined by the values of the capacitors. Continuous change of

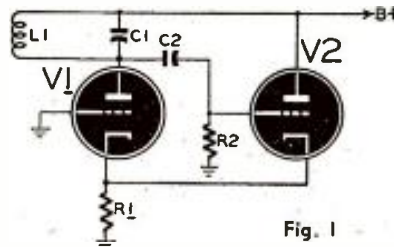

Fig. 1

frequency can be attained by using a large variable capacitor instead of the switch and fixed capacitors, but at audio frequencies, the size of the variable condenser becomes very large.

A cathode follower stage has been

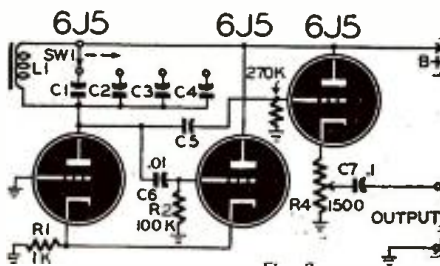

Fig. 2

added to couple the oscillator to the output terminals and to provide a low impedance output.

Potentiometer R4 serves as the output level control and the cathode load resistor. Changes in the output load and adjustment of the output level should have very slight—if any—effect upon oscillator frequency.

LEO G. SANDS,
Towson, Maryland

MICROPHONE PREAMPLIFIER

This compactly built preamplifier has enough voltage gain to couple a crystal microphone into the audio frequency end of practically any home radio receiver. It is designed around the 6SJ7, connected as pentode with an approximate voltage gain of 100. Carefully selected

resistors and condenser values give this unit excellent frequency response.

In keeping with our desire to make

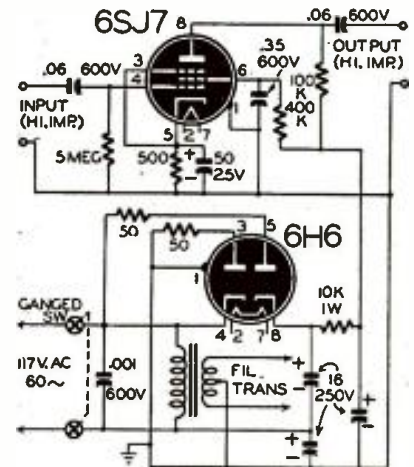

RESISTORS .25W, EXCEPT AS NOTED.

the unit as compact as possible; an a.c.-d.c. circuit was used. As the current ratings of a 6H6 will not be exceeded by the current demands of the 6SJ7, a 6H6 working into a R-C filter was used as a full-wave voltage doubler.

The filament requirements for the tubes are met by using a small 6.3-volt transformer.

Note—The unit may be made more compact by using a 350-ohm line cord resistor.

PAUL FISK,
Montreal, Canada

"MYSTERY" IMPROVEMENT

On page 718 of *Radio-Craft* for August 1945, you published my "mystery" circuit and requested to hear further reports about the set.

It became evident that the 6B5 output tube was operating under difficulties. I therefore took the 6B5 out and substituted a 6A3.

The results were astonishing. Tone quality and general fidelity was improved fully 100%, and the volume and selectivity also registered substantial gains. The whole circuit loosened up and took on new life. Several bugs and gremlins disappeared entirely.

The most "mysterious" and gratifying result obtained was the automatic change from dual to single control. With the regeneration control placed at the extreme position, that position became permanent and the circuit could be perfectly handled over the entire broadcast band by using only the volume control.

The only other change made is the rewinding of the coils with No. 28 enamel wire instead of No. 32 as heretofore used.

RALPH W. MARTIN,
Los Angeles 32, Calif.

RADIO DATA SHEET 335

RCA VICTOR

MODELS 54B1, 54B1-N, 54B2, 54B3

SPECIFICATIONS

Frequency Range 550-1,600 kc.
Intermediate Frequency 455 kc.

ALIGNMENT PROCEDURE

Test Oscillator.—Connect test oscillator as indicated in chart, keeping the output as low as possible to avoid a.v.c. action.

Output Meter.—Connect meter from top lug of TB1 (plate of 354) to ground. Turn volume control to maximum position.

*Steps 3, 4 and 5, shown in alignment table, require a coupling loop from the signal generator to feed a signal into the receiver loop located in the lid. This loop should be approximately one turn of 6 x 3/2 inches coupled to the signal generator through a 200 μ f capacitor, and loosely coupled to the receiver loop antenna at about 1 3/4 inches distance, so as not to disturb the receiver loop in-

ductance. Ground test oscillator through .1 mf. capacitor to receiver chassis.

CRITICAL LEAD DRESS

1. Dress blue, green and black leads of second i.f. transformer as direct as possible. If excess lead exists, dress down side of socket and flat as possible against chassis to transformer opening.
2. Cross the green and the black leads inside the first i.f. transformer can, keeping the green lead to the outside. Keep the blue and the green leads separated as far as possible throughout their length.
3. Dress audio coupling capacitor (C14; .002 μ f.) and the lead to the volume control up and underneath the shelf supporting the output transformer.
4. Dress the three capacitors pyramided behind the speaker, parallel to the complete assembly and with enough



room behind the battery holder to allow the holder to move when a battery is installed or removed.

5. Dress the "B" battery leads behind the gang frame and over the top of the output transformer.
6. Observe the outside foil connections on all paper capacitors, also the polarity of the electrolytic capacitor (C17).
7. Keep blue and red leads of output transformer above the mounting shelf.

Note: Do not install "A" battery without cardboard cover.

A rubber band should be placed around each one of the tubes for cushioning.

TABULATION FOR ALIGNMENT

Steps	Connect the high side of test osc. to—	Tune test-osc. to—	Turn radio dial to—	Adjust the following for max. peak output—
1	Connection lug of C2, located on rear of gang in series with .01 μ f.	455 kc.	Quiet point near 1,600 kc.	C11, C12 2nd i.f. trans.
2		455 kc.	Quiet point near 1,600 kc.	C8, C9 1st i.f. trans.
3	*Antenna coupling loop thru 200 μ f. capacitor (See "Alignment Procedure" for explanation.)	1,600 kc.	1,600 kc.	C5 (osc.)
4		1,500 kc.	1,500 kc.	C2 (ant.)
5		600 kc.	600 kc.	L2 (osc.)
6	Repeat steps 4 and 5 for final adjustments.			

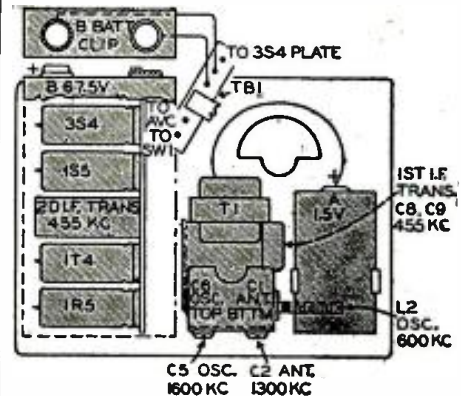

Positions of trimming, padding and i.f. trimmer condensers.

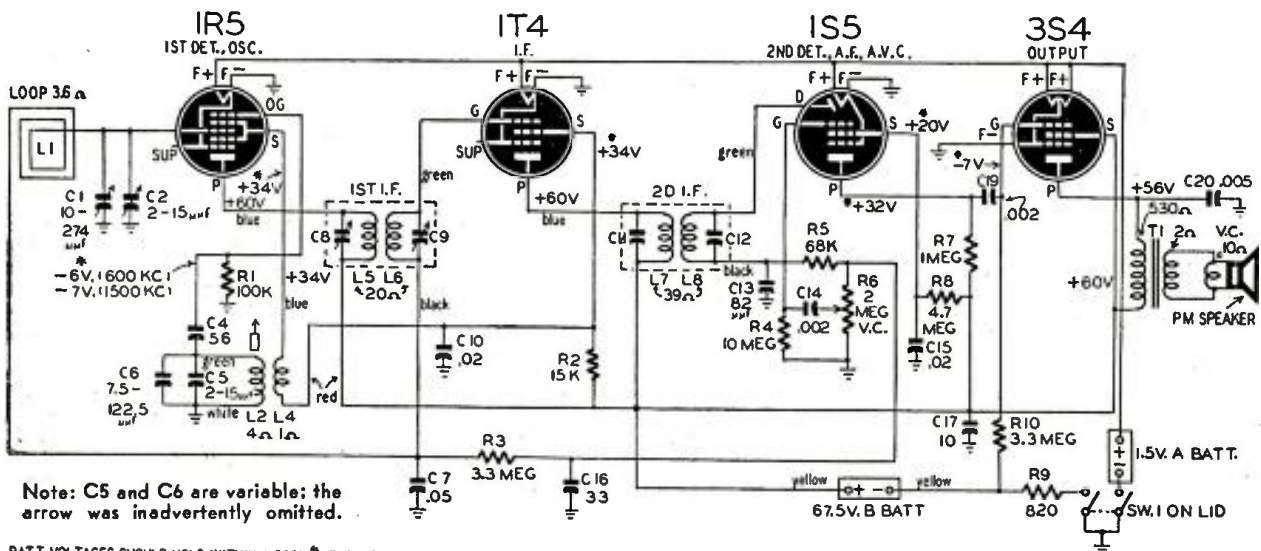

Note: C5 and C6 are variable; the arrow was inadvertently omitted.

BATT. VOLTAGES SHOULD HOLD WITHIN $\pm 20\%$, *MEASURED WITH CHANALYST OR VOLTOHMST. VOLTAGES MEASURED WITH RESPECT TO CHASSIS GROUND.

NEW

RADIO-ELECTRONIC DEVICES

SWEEP CALIBRATOR

United Cinephone Corp.
Torrington, Conn.

This instrument provides calibration marks for use in calibrating the sweep speed of a synchroscope or triggered sweep oscilloscope. The markers consist of short video pulses, of less than $\frac{1}{2}$ microsecond duration, spaced apart by an exactly known number of microseconds.

Ranges: Switch permits choice of four different time intervals between calibration markers: 2.5, 10, 50 and 100 microseconds.



Markers have an amplitude of 40 volts, with choice of polarity.

Trigger Pulse (internally generated): Choice of polarity. The positive trigger has an amplitude of 120 volts; negative 65 volts. The repetition rate is continuously variable by means of a calibrated control from 2000 to 3000 c.p.s.

Operation from an external trigger pulse, either positive or negative, of 66 volts.

Gate: Continuously variable duration of 20 to 3000 microseconds. (gate length is length of time during which markers are generated following each trigger pulse. All markers that would appear subsequent to this interval are suppressed.)—*Radio-Craft*

INSTRUMENT RESISTORS

Instrument Resistors Co.
Little Falls, N. J.

Four new types—ALA, ACA, BLA and BCA offer the advantages of close tolerance, high quality and low unit cost. Type ALA is a 3-watt resistor, with a maximum resistance of 2500 ohms in



nichrome and 5000 ohms in manganin. Type BLA, rated at 5 watts, runs to 50,000 ohms (nichrome) and 10,000 ohms (manganin). Types ACA and BCA are the same as ALA and BLA except for a coating of high-temperature cement.—*Radio-Craft*

PRECISE VOLTAGE SUPPLY

Clippard Instrument Laboratory
Cincinnati, Ohio

This custom-built instrument furnishes a.c. potentials of laboratory accuracy in 1/10th-volt steps from 0 to 111 for laboratory or production line use in testing and calibration of a.c. meters, vacuum tube voltmeters or other circuits where a known source of a.c. voltage is required.

It incorporates a precision transformer of the true isolating type with a primary tapped to adjust within one tenth of one volt of line voltages from 100 to 132. Secondary is precision tapped to provide output voltages of 0 to 111 in 1/10th-volt steps.

A Weston meter, model 476, is placed in the secondary circuit for highest accuracy and is calibrated with a single red line to indicate proper primary voltage adjustment. When the primary is adjusted to 100 volts the instrument may also be used as a variable ratio transformer provided input voltages do not exceed calibration settings. One-thousand-to-one to one-to-one values in steps of one one-thousandth are furnished in ranges up to 10,000 cycles.



Output is conservatively rated at 30-volt-amperes as follows: 0.1 to 1 volt, 5 amperes permissible current; .01 to 11 volts, 2 amperes; 0.1 to 31 volts, 1 ampere; 0.1 to 111 volts, 0.3 amperes. Accuracy of 1% is guaranteed for the voltage output of one-quarter of 1% for the ratios.—*Radio-Craft*

CARDIOID MICROPHONE

Electro-Voice, Inc.
South Bend, Indiana

A new cardioid unidirectional crystal microphone, with high output, dual frequency response selection, and other features is announced.

The new CARDAX has a dual frequency response selector on back of microphone which enables wide range

flat response for high fidelity sound pick-up or wide range with rising characteristic for extra crispness of speech or high frequency emphasis.

It is designed for high quality pick-up and reproduction of voice and music—in public address, recording and remote broadcast communications.—*Radio Craft*



COLD-CATHODE RECORDER

Sylvania Electric Products Co.
Boston, Mass.

The R-1130 is a modulator glow tube of the crater type that is rugged and dependable for facsimile and sound-on-film recording; oscillograph timing markers; stroboscopic devices; seismic recorders; and photo-electric counters.

The tube, usually operated by the single-ended output stage of a push-pull amplifier, provides a modulated, high-intensity point-of-light source by means of a hollow cathode producing high ionization density which may be viewed in depth. Current through the tube varies linearly with the signal voltage regardless of changes in tube impedance.

Used in a typical facsimile receiver the light output of the tube is focused through a baffle with a sharp rectangular opening to produce a spot of light .0072-inch high and .0104-inch wide on a drum rotating at 90 r.p.m. Scanning movement is .0104-inch per revolution.

Type R-1130 recording tube is supplied in a T-9 bulb with intermediate shell octal base and may be operated in any position. Providing a useful light range between 3500 and 6500 angstroms it will respond to frequencies between 15 and 15,000 c.p.s. Rated at 135 volts d.c. with currents ranging from 5 to 35 ma, it requires a starting voltage of 170 d.c. maximum.—*Radio-Craft*

FM CARRIER STABILIZATION

(Continued from page 538)

a buffer stage and individual low pass filters and then applied to a phase discriminator of the conventional type known to FM technicians and repairmen (Fig. 11). The magnitude of the discriminator a.c. output voltage depends upon the difference of phase between the two applied frequencies A and B. The polarity depends upon whether the Hartley oscillator frequency A drifts upward or down.

The low-pass filter which follows the discriminator grounds out the rapid a.f.

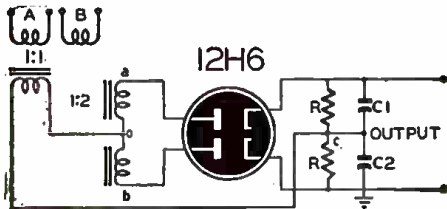

Fig. 11—The 12H6 output corrects frequency.

modulation and permits only the varying voltage caused by gradual frequency drifts to affect the grid bias of the Miller tube (V-903). Change of grid bias of this tube varies the input capacitance and therefore the frequency of the Hartley tank coil across which it is connected. The original frequency drift of the Hartley oscillator is compensated for in this way.

The output frequency of the CFS and modulator unit is multiplied in succeeding stages to bring it into the FM band. The center frequency of this transmitter is maintained to within .001 per cent of its assigned values.

THE RCA ANTENNALYZER

(Continued from page 536)

value of the same signal. The instrument panel used for this purpose may be seen near the top of the Antennalyzer. The signal from the Antennalyzer is fed first to the peak-reading voltmeter which consists essentially of a diode rectifier. The input signal is adjusted until the meter in the output reads full scale. Then the signal is switched to the input of the r.m.s. voltmeter. The output meter is switched to this voltmeter at the same time. Since the meter scale is calibrated with full scale equal to unity, the new reading is now the ratio of the r.m.s. signal to the peak signal.

A supersonic reflectoscope using sound waves to locate flaws in solid objects has been developed at the University of Michigan, reports Dr. Floyd A. Firestone of the departments of physics and engineering research of the University. It uses a quartz crystal covered with a film of oil to contact the object being tested.

NEW and ALLIED'S 1946 CATALOG

Ready for you!

of Radio and Electronic Supplies



FREE

Send for it Now!

LARGEST AND MOST COMPLETE STOCKS

Today's handiest, most complete *Buying Guide!* Brings you latest, finest values in parts, tubes, kits, tools, books, test instruments, communications receivers, Ham gear, public address and other equipment. Places at your finger tips over 10,000 items of nationally known guaranteed quality. Makes available to you the world's largest and most complete stocks under one roof . . . ready for rush delivery. Enables you to get everything you need in radio and electronics from one dependable, central source. Send for this new 1946 Catalog now. Save time, work and money!



NEW RADIO SETS

Parade of new 1946 models, including phonoradios, and latest communications receivers covering broadcast, short-wave and amateur bands. Beautiful styles! Wonderful performance! Outstanding values!



HANDY RADIO BOOKS AND CALCULATORS

Radio Formulas & data, Dictionary of Radio Terms, Radio Circuit Handbook, Radio Builders' Handbook, Simplified Radio Servicing, Radio Data Handbook — Six Books No. 37-799, 75c.
Parallel Resistance and Series Capacitance Calculator, No. X37-960 25c.
R-F Resonance and Coil Winding Calculator, No. 37-955 25c.



OVER 10,000 ITEMS

Biggest section of quality parts and equipment for engineers, dealers, servicemen, soundmen, amateurs, builders. All leading makes, at lowest prices. Send for Free Catalog now.



NEW P. A. EQUIPMENT

Sound systems for every public address requirement. Complete listing of amplifiers, speakers, microphones, accessories. Newest developments with many exclusive features.

ALLIED RADIO CORP.

833 W. Jackson Blvd., Dept. 2-EE-6
Chicago 7, Illinois

Date
 Send FREE New 1946 Catalog.
 Send Six Books—Calculator No. } \$..... enclosed
 Calculator No. }

Name
 Address
 City Zone State

ALLIED RADIO

Everything in Radio and Electronics

WORLD-WIDE STATION LIST

(Continued from page 544)

<p>9.900 GRY 9.908 ZRL 9.910 ZYCB 9.910 MCH 9.915 TPG 9.923 CXAG 9.925 XGCA 9.925 GWO 9.930 CKLO 9.940 GVZ 9.946 XGOV 9.960 GWP 9.960 HVJ 9.960 HHBM 9.970 WRCA 9.970 VUD10 9.975 JVV2 9.975 GWT 9.980 XEQQ 9.980 VLC2 9.980 EQC 9.983 LRAI 9.985 TGWA 9.990 GRX 9.700 WRUS 9.700 KCBF 9.700 KCBR 9.705 9.710 CR7BE 9.715 9.720 PRL7 9.730 XG0A 9.735 CSW7 9.735 CXA15 9.745 OTC 9.750 WLWRI 9.750 KCBF 9.750 WNRA 9.760 TGWA 9.763 OTC 9.785 OAX5C 9.800 HNF 9.823 9.825 GRH 9.833 COBL 9.855 KWID 9.860 9.897 WBOS 9.900 ZTJ 9.915 GRU 9.930 SVM 9.958 HCJB 10.000 WWV</p>	<p>LONDON, ENGLAND: African beam, 12:15 to 4 pm; Near East beam, 2:30 to 4 pm; Middle East beam, 11 pm to 1:45 am; Australian beam, 11 pm to 3 am. CAPE TOWN, SOUTH AFRICA: 3 to 7 am; 9 am to 4 pm. RIO DE JANEIRO, BRAZIL: evenings till midnight. LUXEMBOURG: heard irregularly at 4:30 pm calling New York. SAN JOSE, COSTA RICA: 9 pm to 12:30 am. MONTEVIDEO, URUGUAY: 3:30 to 8 pm. Somewhere in China: 6 to 7:45 am. LONDON, ENGLAND: African beam, 12 to 1:15 am; Middle East beam, 12:15 to 12:30 am; 1:30 to 2 pm; 4:15 to 4:30 pm; European beam, 12 to 12:30 am; 1 to 2:45 am; 5 to 7:30 am; 10 am to 11 am; 12 to 1:30 pm; 2 to 5:45 pm. MONTREAL, CANADA: European beam, 3:15 to 7 pm. LONDON, ENGLAND: North American beam, 4:15 pm to 11:45 pm; New Zealand beam, 12 to 4 am. CHUNGKING, CHINA: East Asia and South Seas beam, 6:35 to 8:40 am; North American beam, 8:45 to 10:40 am; European beam, 10:45 am to 11:30 am; East Asia and South Seas beam, 11:30 am to 12:45 pm. LONDON, ENGLAND: African beam, 11 pm to 1:15 am; Far East beam, 11 pm to 3:45 am; North African beam, 1 to 2:45 am. VATICAN CITY: noon to 1:30 pm; 1:45 to 2:30 pm. PORT AU PRINCE, HAITI: 5 to 8:30 am; 11 am to 2 pm; 5 to 9 pm. MOSCOW, U.S.S.R.: 4:30 to 9:15 pm. NEW YORK CITY: Brazilian beam, 10 to 10:30 pm. DELHI, INDIA: 7:20 to 11:30 am. TOKYO, JAPAN: 2 to 5 am; 5:30 to 7:15 am; 7:30 to 9:40 am; 9:55 to 11:40 am; 12 to 1:40 pm; 4:30 to 6:45 pm. LONDON, ENGLAND: African beam, 1:45 to 2:15 pm; Canary Islands beam, 1:30 to 1:45 am; 2:15 to 2:30 am; 3 to 3:30 pm; European beam, 1 to 2 am; 5 to 7:30 am; 10:15 am to 12 pm; 12:30 to 1:30 pm; 2:15 to 4 pm. MEXICO CITY, MEXICO: evenings. SHEPPARTON, AUSTRALIA: Northern Asiatic beam, 2:30 to 3:30 am; British beam, 11:15 am to 11:45 am. TEHERAN, IRAN: 1 to 3:30 pm. BUENOS AIRES, ARGENTINA: 6 to 8:30 pm. GUATEMALA CITY, GUATEMALA: Sundays at 6:55 pm. LONDON, ENGLAND: Australian beam, 12 to 4 am. BOSTON, MASS.: Central American beam, 6:30 pm to 1 am. SAN FRANCISCO, CALIF.: Oriental beam, 1 to 4:45 pm. LOS ANGELES, CALIF.: Oriental beam, 2 to 4:45 am; 5 to 11 am. FORT DE FRANCE, MARTINIQUE: heard 5:30 pm. LOURENCO MARQUES, MOZAMBIQUE, 2 to 3:30 pm. MOSCOW, U.S.S.R.: 6:30 to 7:30 am. RIO DE JANEIRO, BRAZIL: 3 to 9:30 pm. CHUNGKING, CHINA: 12:30 to 1:45 am; 5:30 to 10:15 am. LISBON, PORTUGAL: 7 to 8 pm. MONTEVIDEO, URUGUAY. LEOPOLDVILLE, BELGIAN CONGO: relay BBC at 8:30 to 11:45 pm. CINCINNATI, OHIO: North African beam, 3:15 to 6 pm. LOS ANGELES, CALIF.: South American beam, 11 pm to 1 am; East Indies beam, 4 to 9:45 am. NEW YORK CITY: European beam, 1:45 to 6 pm. GUATEMALA CITY, GUATEMALA: evenings. LEOPOLDVILLE, BELGIAN CONGO: relay BBC at 9:30 pm to 12:45 am. INCA, PERU: evenings. BAGHDAD, IRAQ: 9 am to 4 pm. VIENNA, AUSTRIA: midnight to 2 am; 6 to 8 am; 10 am to 4:30 pm. LONDON, ENGLAND: North American beam, 4:15 pm to 11:45 pm. HAVANA, CUBA: 7:15 am to 12:45 am. SAN FRANCISCO, CALIF.: South Pacific beam, 2:30 to 6:30 am. MOSCOW, U.S.S.R.: 8 to 9:30 pm; 10 pm to 2 am; 8:30 to 9:30 am; 10 am to noon. BOSTON, MASS.: European beam, midnight to 3:15 am; 1 to 5:45 pm. JOHANNESBURG, SOUTH AFRICA: 7:15 to 7:45 am. LONDON, ENGLAND: African beam, 12:30 to 3:30 pm; 3:45 to 4:45 pm; Indian beam, 11:15 am to 12:15 pm; Mediterranean beam, 3:45 to 4:45 pm; North African beam, 12:30 to 3:30 pm. ATHENS, GREECE: heard 1 to 6 pm. QUITO, ECUADOR: afternoons and evenings. WASHINGTON, D.C.: U.S. Bureau of Standards; frequency, time and musical pitch; broadcasts continuously day and night.</p>	<p>10.000 XGOL 10.220 PSH 10.400 YPSA 10.420 VLN 10.450 10.510 KUIG 10.730 VQZLO 10.780 SDB2 11.040 CSW6 11.090 11.115 MCH 11.145 WCBN 11.585 VRR4 11.616 COK 11.640 PVZ 11.645 11.650 XTPA 11.680 CMCY 11.680 GRG 11.690 XGRS 11.696 HP5A 11.700 GVV 11.705 SBP 11.705 CXA19 11.705 CBFY 11.710 WLWS2 11.710 WLWK 11.710 VLGS 11.715 HEI5 11.718 CR7BH 11.720 PRL8 11.720 CKRX 11.720 OTC 11.725 JVV3 11.730 KGEI 11.730 WRUW 11.730 KGEX 11.730 WRUL 11.730 GVV 11.720 CHOL 11.740 COCY 11.740 CEI174 11.740 HVJ 11.750 GSD 11.760 VLG10 11.785 11.770 KCBA 11.770 VLA4 11.780 GVV 11.780 HP5G 11.780 OIX3 11.785 11.790 WRUS 11.790 KNBA 11.800 GWH</p>	<p>FOOCHOW, CHINA: 5 to 9 am; 11:30 pm to 1 am. RIO DE JANEIRO, BRAZIL: evenings. SAN SALVADOR, EL SALVADOR: heard evenings. SYDNEY, AUSTRALIA: around 12:15 am. MOSCOW, U.S.S.R.: midnight to 2 am; 9:30 to 10 am. GUAM: heard calling NBC around 5:30 pm. NAIROBI, KENYA: 9 am. STOCKHOLM, SWEDEN: 3:15 to 5 pm. LISBON, PORTUGAL: Brazilian beam, 12:30 to 3 pm; 4 to 6 pm. PONTO DEL GADA, AZORES: 3 to 4 pm. LUXEMBOURG: heard with Army hour for New York. NEW YORK CITY: European beam, 1 to 5:45 pm. JAMAICA, BRITISH WEST INDIES: heard at 10 am. HAVANA, CUBA: 11 am to 11 pm. MANILA, PHILIPPINES: 6:30 to 7:15 am; evenings. BRUSSELS, BELGIUM: evenings about 7:30 pm. CANTON, CHINA: 7 to 9:15 am. HAVANA, CUBA: afternoons and evenings. LONDON, ENGLAND: Far East beam, 9 to 10:15 am; Middle East beam, 12 to 2:15 pm. SHANGHAI, CHINA: 10:15 am to 11:30 am. PANAMA CITY, PANAMA: 7 am to 11 pm. LONDON, ENGLAND: African beam, 10:30 am to 4 pm. STOCKHOLM, SWEDEN: 8 to 9 pm; 1:45 to 2:15 am; 6 to 7 am. MONTEVIDEO, URUGUAY: 8 to 9 pm. VERCHERES, CANADA: 10 am to 11 am. CINCINNATI, OHIO: South American beam, 5 to 7:15 pm; 7:30 to 9:30 pm. CINCINNATI, OHIO: European beam, 7:30 am to 4:30 pm. MELBOURNE, AUSTRALIA: North American beam, 10 to 10:45 am; 8:45 to 9:45 pm; Tahiti beam, 1 to 1:40 am; British beam, 1:55 to 2:25 am; Northern Asiatic beam, 2:30 to 2:55 am. BERNE, SWITZERLAND: Tuesday and Saturday, 10 am to noon. MARQUIS, MOZAMBIQUE. RIO DE JANEIRO, BRAZIL: 9:30 to 9:55 pm; off Saturdays and Sundays. WINNIPEG, CANADA. LEOPOLDVILLE, BELGIAN CONGO: 5:30 to 7:30 am. TOKYO, JAPAN: heard at 1 pm. SAN FRANCISCO, CALIF.: South-west Pacific beam, 1 to 4:45 pm. BOSTON, MASS.: European beam, 1 to 5 pm; Caribbean beam, 5:15 to 5:45 pm. SAN FRANCISCO, CALIF.: South-west Pacific beam, 2 to 4:45 am. BOSTON, MASS.: North African beam, 6 to 8:45 am; Mexican beam, 6:30 pm to 1 am. LONDON, ENGLAND: Far East beam, 12 to 4:45 am. MONTREAL, CANADA: European beam, 2:15 to 7 pm. HAVANA, CUBA: afternoons. SANTIAGO, CHILE: 7 am to 11:30 pm. VATICAN CITY: noon to 1 pm. LONDON, ENGLAND: African beam, 12 to 3 am; 10:30 am to 4 pm; South American beam, 4 to 9:15 pm; Mediterranean beam, 2 to 3 am; 4 am to 4 pm; North African beam, 2 to 3 am; 4 am to 3:30 pm. MELBOURNE, AUSTRALIA: 3:55 to 5:15 am. ALGIERS: 6 am to noon. SAN FRANCISCO, CALIF.: South American beam, 11 pm to 1 am; 5 to 10:45 pm; Oriental beam, 1 to 4:45 pm. MELBOURNE, AUSTRALIA: North American beam, 12:10 to 12:40 am. LONDON, ENGLAND: Indian beam, 11 pm to 1:15 am; Australian beam, 11 pm to 1:15 am; European beam, 5 to 7:45 am; 10:15 am to 4:15 pm; African beam, 5:30 to 6:45 am; 7:15 to 7:45 am; 10:30 am to 11 am; 11:30 am to 1 pm. PANAMA CITY, PANAMA: daytimes and evenings. MOSCOW, U.S.S.R.: 9 to 10 am. LAHTI, FINLAND: 2:30 to 3 am; 6 to 7 am; 8:15 to 8:45 am; 1 to 5 pm; 5:45 to 6:15 pm; 8:15 to 8:30 pm. BRUSSELS, BELGIUM: 5:30 to 6 pm; 8 to 8:15 pm. BOSTON, MASS.: European beam, 6 am to 4:15 pm; 4:30 to 6 pm. SAN FRANCISCO, CALIF.: Philippine beam, midnight to 3:45 pm; South American beam, 5 to 11:45 pm. LONDON, ENGLAND: African beam, 1:45 to 2 am; 7 to 7:15 am; Canary Islands beam, 1:30 to 1:45 am; European beam, 1 to 2 am; 5 to 7:45 am; 10:15 am to 12 pm; 12:30 to 1:30 am.</p>
--	---	--	--

36 COURSES IN ONE only \$5 COMPLETE

Send the coupon today! Examine Ghirardi's famous RADIO PHYSICS COURSE. See for yourself how this giant 972 page, 3 1/2 lb. book at ONLY \$5 gives complete basic training that can pave your way to a good paying job or business of your own in Radio, Television, F.M. Facsimile, Broadcasting, Communications, etc. See how its 972 profusely illustrated pages give just the training you need—ALL YOU NEED—easier, better, faster—AND AT FAR LESS COST. No previous training is necessary. Every step is made crystal clear. Many beginners have completed it in a few weeks. Thousands of Ghirardi-trained men now hold important Radio-Electronic positions.

No training AT ANY PRICE is more widely endorsed by experts themselves.



LEARN FAST...

LEARN RIGHT

at a Price You Can Afford!

Ghirardi's RADIO PHYSICS COURSE makes Radio-Electronics-Television amazingly easy to learn. Everything is explained carefully and thoroughly in a clear, easy style you cannot fail to understand. No involved mathematics. No lessons to wait for. No time lost. You get your training easily and quickly—while the big money-making opportunities still beckon on every side. You'll be amazed to find how soon RADIO PHYSICS COURSE has you familiar with every phase of this fascinating subject—how it enables you to grasp subjects that other books and courses make seem highly complicated. Best of all, you buy it on an UNRESERVED 5-DAY MONEY-BACK GUARANTEE.

Every cent of your money will be refunded if you are not more than satisfied. Send coupon today!

USE COUPON
at bottom of adjoining page

REPAIR RADIOS EASIER AND TWICE AS FAST!

This Big 4-lb. Manual-size Radio Troubleshooter's Handbook Shows Exactly How to Diagnose and Repair Common Troubles in Practically Every Radio in Use



NOT A STUDY BOOK!

A repair data Handbook that goes to work for you the minute it arrives!

Speed up radio repair work! Eliminate much needless, tedious testing! Handle common radio troubles fast and profitably. Make spare time money repairing sets—without costly equipment or experience.

MAKE MORE MONEY—FASTER!

Ghirardi's famous 744-page, manual-size RADIO TROUBLESHOOTER'S HANDBOOK shows you what to do—exactly how to do it. Over 400 pages give common trouble symptoms, their causes and remedies for over 4,800 receivers, auto radios and record changers of 202 different manufacturers. Just look up the Make, Model and Trouble Symptom of the

radio to be repaired. Four times out of five, the HANDBOOK will show you step by step just what to do—in a fraction of the usual time. Ideal for either busy repair shops or beginners. Pays for itself in time saved on the very first job.

Over 300 additional manual-size pages include service hints; i-f alignment peaks for over 20,000 superhets; transformer trouble data; the most complete tube information you've ever seen; color codes; and hundreds of graphs, diagrams, charts, etc.—all carefully indexed so you can find what you need in a hurry. Price only \$5—on 5-DAY MONEY-BACK GUARANTEE BASIS. See Money-Saving Combination.

LET GHIRARDI TEACH YOU THE "SECRETS" OF MAKING REAL MONEY IN RADIO SERVICING.

Eliminate much needless testing! Repair two sets in the time normally required for one!



BE A PROFESSIONAL RADIO-ELECTRONIC SERVICING EXPERT

Let Ghirardi Scientific Training Prepare You for the Big Money Class!

MODERN RADIO SERVICING is Alfred A. Ghirardi's famous 1300-page 1-volume course in PROFESSIONAL radio-electronic service work. It gives the kind of training that will be your "Open sesame!" to the better money-making opportunities that only scientifically trained servicemen will be in a position to grasp—including profitable industrial electronic work. It explains all types of test instruments. Shows how to analyze circuits professionally; how to use all types of test equipment for troubleshooting; how to test, repair and replace components; how to make substitutions—how to handle every phase of radio repair work from A to Z by approved MODERN methods. Absolutely "tops," either as a basic course in the entire field of radio-electronic servicing, or as a "refresher" on any type of work that puzzles you. Worth its weight in gold in giving you real Know-How and paving your way to a profitable radio-electronic-television servicing future. 1300 pages; 706 illustrations; 720 self-test review questions. Only \$5. 5-DAY MONEY-BACK GUARANTEE.

MONEY-SAVING OFFER!

Let RADIO TROUBLESHOOTER'S HANDBOOK save time on common service jobs. Let MODERN RADIO SERVICING train you for professional radio-electronic service work. Get BOTH big books at special Money-Saving Combination price of only \$9.50 for the two. Act at once! Send coupon now!

LEARN ALL ABOUT ELECTROLYTIC CAPACITORS

Don't buy, specify, use or replace capacitors blindfolded! They are among the most important components in radio-electronic equipment. Read Alexander M. Georgiev's book, THE ELECTROLYTIC CAPACITOR and learn the facts! Tells all about the various electrolytic types . . . their construction, characteristics, advantages, applications, measurement, testing, defects, making emergency repairs, etc. Shows when and where to use the various types; describes wets versus dries; applications at low and high voltages and frequencies; a-c or pulsating d-c uses; ambient conditions, etc. Over 200 pages. \$3 (\$3.25 foreign). Use coupon.

The only modern book of its kind. Profusely illustrated.

5 DAY MONEY-BACK GUARANTEE

MURRAY HILL BOOKS, INC.

Dept. RC-56, 232 Madison Ave., New York 16, N. Y.

Enclosed find \$..... for books checked; or send C.O.D. (no foreign C.O.D.'s) for this amount plus postage. If not fully satisfied, I may return books within 5 days for full refund.

RADIO PHYSICS COURSE (See adjoining page) \$5 (\$5.50 foreign)

RADIO TROUBLESHOOTER'S HANDBOOK \$5 (\$5.50 foreign)

THE ELECTROLYTIC CAPACITOR \$3 (\$3.25 foreign)

MODERN RADIO SERVICING \$5 (\$5.50 foreign)

MONEY-SAVING COMBINATION OFFER: Both Troubleshooter's Handbook AND Modern Radio Servicing, only \$9.50 for the two (\$10.50 foreign).

Name

Address

City and District No. State

YOU'LL NEVER GO WRONG ON A Ghirardi BOOK!

TRY THIS ONE

CODE OSCILLATOR

It is possible to obtain the tone of an actual c.w. station by connecting your code practice oscillator to the input of a phono oscillator. The signal is then picked up by a receiver in the same manner as an ordinary recording would be.

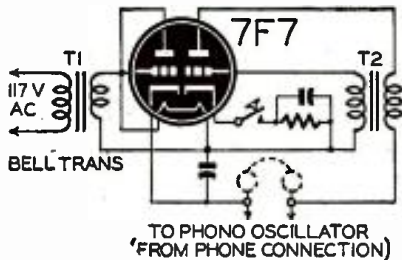

With many types of phono oscillators, it may be necessary to connect a resistor of 50 to 100 thousand ohms across the output of the code unit to bring the B voltage to the plate. A by-pass condenser of about .005 μ f should be used across it to pass the r.f. current or in many cases the tube will not oscillate.

A series condenser of about .05 μ f is usually necessary to prevent d.c. from being applied to the grid of the first tube in the phono oscillator, depending on the circuit.

JOHN WINKLER,
Big Rapids, Mich.

WINDING INDICATOR

An old "Readrite" or similar moving-vane type of meter, or one that has a burnt-out winding can be utilized as an excellent test meter to differentiate between the various windings of a power transformer. Some transformers are not coded in accordance with RMA specifications.

To test, the meter is simply laid on top of the core of the transformer. Then each winding is excited by connecting the leads to a 1.5-volt dry cell. There will be only a slight deflection when the high-voltage leads are connected, but the 5-volt and 6.3-volt windings will indicate approximately half-scale deflection. The 5-volt winding will read slightly higher than the 6.3-volt winding while a 2.5-volt filament winding will read highest of all. With a little practice and some sort of calibrated chart, the settings for each winding can be discovered. It will then be possible to determine whether any windings are shorted partially or completely.

It would not be advisable to use a meter that is still in regular daily use, as the intense magnetic field developed may cause a change in the meter magnet which would cause inaccuracy in future voltage readings.

PETER R. HEATH,
Stettler, Alberta

RADIO-CRAFT welcomes new and original radio or electronic circuits. Hook-ups which show no advance on or advantages over previously published circuits are not interesting to us. Send in your latest hook-ups—RADIO-CRAFT will extend a one-year subscription for each one accepted. Pencil diagrams—with short descriptions of the circuit—will be acceptable, but must be clearly drawn on a good-sized sheet.

POWERLESS INTERCOM

A good intercommunicator, for short distances, may be made without using batteries or switches.

Two 3-inch PM dynamic speakers are connected to output transformers (500-ohm to voice-coil) and the primary windings of the transformers connected together by a line.

By speaking into one of the speakers, from a short distance, a voltage is set up within the voice coil and stepped up on the secondary. It is then passed

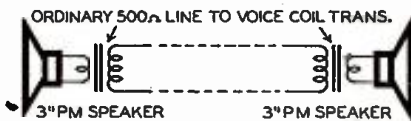

through the primary of the other transformer and the voice coil is excited. This works remarkably well with the new high-efficiency speakers which use Alnico magnets.

E. A. CHAPMAN,
Alberta, Canada

SIMPLE WIRE GAUGE

A handy wire gauge may be made by mounting wire of various known sizes on a piece of 12 by 8 inch white cardboard. The wires may be held on the board by small strips of cellulose tape. The size of the wire is noted just below the test strips. When it is necessary to determine the size of a wire, it is held side by side with the test strips until the two sizes are matched.

JOHN TREBYCH, JR.
Fruitland, Ont.

(This method is actually as accurate as a standard wire gauge for measuring the smaller wire sizes.—Editor)

TWO SHORTWAVE KINKS

A music stand base makes a FB antenna for either 2½ or 1¼ meter bands, giving directional characteristics in three directions. If legs are adjustable, experiment to find resonant length. Approximately 14 inches is a half-wave at 2½ and a quarter-wave at 1¼ meters.

A five-cent pyrex bowl makes a good feed-through insulator. Drill through, using low pressure drill and light oil for lubrication. Total cost is twenty cents compared to about \$3.00 when purchased complete.

GERALD SAMKOFKY,
Brooklyn, N. Y.

EMERGENCY B.F.O.

In the middle of a code practice session my beat-frequency oscillator failed to work. Having a small home receiver on a nearby table, I tuned it to the high frequency end of the broadcast band. It is possible to pick harmonics from the oscillator of the broadcast set. These harmonics can be made to beat with the incoming signal of the communication receiver thus making the unmodulated signal audible.

For example, it is desired to beat a signal with an incoming signal of 9.5 megacycles. The broadcast receiver is tuned to approximately 1130 kilocycles. It will then be possible to make the sixth harmonic of the oscillator beat with the incoming signal.

When using the b.f.o. to search for a station, it is necessary to know the exact frequency of the station being sought.

S. A. WHITT,
Princeton, W. Va.

NOVEL POWER SUPPLY

A center-tapped output transformer may be adapted for service as a power transformer by using it in the manner described in the circuit.

The primary of the transformer is used as a center-tapped auto-transformer and the high voltage output is fed to the plates of a OZ4. This tube was selected because it does not require cathode heating voltages. The filter section is the conventional "brute-force" type and with the values specified, it is possible to get 220 volts d.c. from the output.

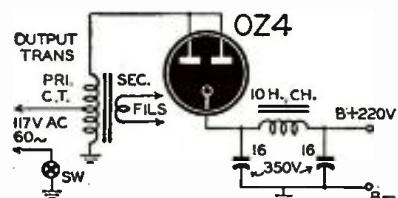

The turns ratio of some transformers is such that the voice coil will yield a usable voltage which may be applied to heat filaments. Using a heavy transformer designed to work into several output impedances, it may be possible to find some combination where standard filament voltages are available.

IRWIN STELZER,
Yonkers, N. Y.

FLUORESCENT UNIT

A portable or mobile fluorescent lamp can be made by connecting the fluorescent bulb across the high-voltage secondary winding of a 6-volt vibrator pack. The battery I used was a car battery. The vibrator pack was from an old auto radio. The 20,000-ohm resistor is an adjustment for maximum results.

SANTOS TIJERINA,
Dilling, Texas

N. U. SAV-A-SHAFT VOLUME CONTROLS

save work...time...material

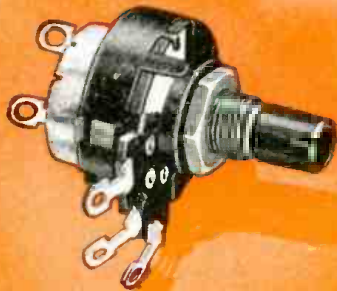

With only 10 types you handle
95% of all control replacements

Try Sav-a-Shaft and see for yourself how much easier they are to install. Learn about their velvety smooth operation, quietness, long life. Note the convenience and profit in handling practically all replacements with *only 10 types*. Order an assortment today from your N. U. Distributor. Prompt delivery assured.

NATIONAL UNION RADIO CORPORATION
Newark 2, New Jersey



**Two simple operations give you
eight big advantages**

1. Cut shaft off old control
 2. Insert shaft in bushing of new Sav-a-Shaft control
- No stock problem
 - No replacement headaches
 - Eliminates shaft, and size and knob fitting problems
 - Any standard shaft adaptable to these controls
 - Each control complete with Switch (switch operates only when lug is released)
 - Easily installed in those hard-to-get-at chassis
 - All midget size for simplicity
 - Gives you tapped controls where needed

NATIONAL UNION RADIO TUBES AND PARTS



Transmitting, Cathode Ray, Receiving, Special Purpose Tubes • Condensers • Volume Controls • Photo Electric Cells • Panel Lamps • Flashlight Bulbs

TURN TO TURNER



★ for Style

★ for Dependability

★ for Performance

Model 22 Microphone Gives You All Three

There's more than beauty of styling behind the Turner 22 Microphone. This famous member of the Turner Line is a precision unit — engineered to faithfully reproduce every desired sound without harmonics or distortions — ruggedly built to perform with unflinching dependability under difficult operating conditions. Good reason why so many leading manufacturers of electronic recording and communications equipment specify the

Turner 22 as standard for maximum performance . . . why you want the TURNER 22 for your equipment. Available in both rugged crystal and dynamic models. Ask your distributor or write for complete performance characteristics.

Turner Microphones Licensed Under U. S. Patents of the American Telephone and Telegraph Company, and Western Electric Company, Inc.

Free Turner Catalog
Write for your copy

You Get These Features in the Turner 22.

- ★ Choice of Moisture Proofed Crystal or Rugged Dynamic Cartridge.
- ★ 90° Tilting Head for Semi- or Non-Directional Operation.
- ★ Removable Cable Set.
- ★ Barometric Compensator.
- ★ Mechanical-Shock Proofing.
- ★ No blasting from Close Speaking.
- ★ Low Feedback.
- ★ Certified Performance.

The TURNER Co.

902 17th Street N.E., Cedar Rapids, Iowa
Pioneers in the communications field

TURNER Microphones

Crystals Licensed Under Patents of the Brush Development Co.

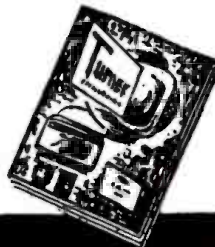

TECHNOTES

. . . . ZENITH 85458

This set was tuning very broadly with low volume. A check of the plate and screen voltages showed these values to be low.

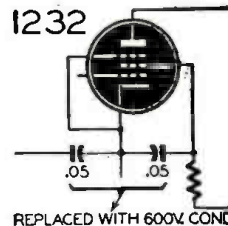

The socket of the 1232 r.f. stage is not immediately available for testing as it is mounted on a sub-panel. Upon dismantling this circuit, it was found that the screen by-pass condenser was leaky. This was replaced with a .05, 600-volt unit. As a precautionary measure, it is wise to replace the a.v.c. by-pass condenser that will be found on the same assembly.

J. SIMRIN,
Bronx, N. Y.

. . . . SHORTED I.F.'S

When shorted i.f. transformers are indicated in sets using shielded units, set the set upright and jar slightly to dislodge any small washers or bits of solder that may have found their way into the trimmer condenser assembly.

If shaking does not remove the trouble, remove the shield before disconnecting the windings from the circuit. In many cases, the short is within the trimmer condenser and not the transformer itself. A surprising number of "shorted" i.f. transformers can be cleared up in this way.

CARL V. FISHBACK,
Hillsboro, Oregon

. . . . PUSH BUTTON RCA AND GE

A frequent complaint on all RCA and GE receivers using separate solenoids for each pre-tuned station, is that the high frequency solenoids cannot be tuned above 1500 kc.

Removing one turn of wire from each of the solenoids in question will cure the trouble.

HUGH A. McCORMICK,
Montreal, Canada

. . . . PHONO OR TONE SWITCH

Occasionally a radio serviceman is called to install a tone control or phono jack on a radio set that was not equipped with one originally. The problem of mounting the control or phono-radio switch without disturbing the symmetry of the other controls is not always a simple one, and practically all customers want their control on the front panel.

If the set is equipped with push buttons of the "electric" type, (switch with separate tuned circuit for each push-button), it is a simple matter to disconnect the leads from one pushbutton switch and use this switch for a two position tone control or for a phono-radio switch.

HUBERT WATKINS,
Gulfport, Miss.



FM radio receivers are more static-free and less costly—thanks to research at RCA Laboratories.

NEW FM - noiseless as the inside of a vacuum tube!

Now, FM, or Frequency Modulation reception, provides still greater freedom from static and interference caused by storms, ignition systems, oil burners, and domestic appliances.

It's radio at its finest—making your living room a part of the concert hall itself. You've no idea of how marvelous music can sound over the radio until you hear the golden perfection of FM reception developed by RCA.

Moreover, through this new RCA development, FM receivers can be made at a cost comparable to that of standard-band broadcast receivers. FM

is no longer expensive! "Better things at lower cost" is one of the purposes of RCA Laboratories—where similar research is constantly going into all RCA products.

And when you buy anything bearing the RCA Victor name—from a television receiver to a radio tube replacement—you know you are getting one of the finest instruments of its kind that science has yet achieved.

Radio Corporation of America, RCA Building, Radio City, New York 20. Listen to The RCA Victor Show, Sundays, 4:30 P.M., Eastern Standard Time, over the NBC Network.



Stuart William Seeley, Manager of the Industry Service Laboratory, RCA Laboratories Division, perfected this new FM circuit. It not only operates equally effectively with strong or weak stations, but lowers the cost of receivers by eliminating additional tubes and parts that were formerly considered necessary in Frequency Modulation receivers.



RADIO CORPORATION of AMERICA

**NEW EDITION
NOW READY**

Audels RADIOMANS GUIDE

Includes **TELEVISION
AND ELECTRONICS**

LARGER - MORE COMPLETE - 914 PAGES - 633 ILLUSTRATIONS - WIRING DIAGRAMS - PHOTOS



**THE KEY TO PRACTICAL
RADIO
INFORMATION**

It gives you in usable form pointers on radio, including frequency modulation, television, etc. Also valuable inside information for Aviators, Marines, Commercial Operators and Technicians, Servicemen and Students.

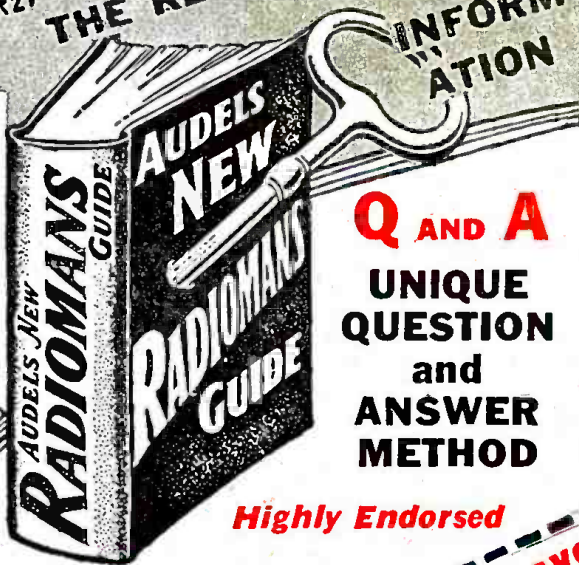

**Q AND A
UNIQUE
QUESTION
and
ANSWER
METHOD**

Highly Endorsed

**1001 RADIO FACTS AND FIGURES
A Complete Library In One Book**

AUDELS RADIOMANS GUIDE gives authentic Principles and Practices in Construction, Operation, Service and Repairs. Covers clearly and concisely radio fundamentals—Ohm's Law—Physics of sound as related to radio science—Measuring instruments—Power supply—Resistors—Inductors—Condensers—Transformers and examples—Broadcasting stations—Radio Telephony—Receivers—Diagrams—Construction—Control Systems—Loudspeakers—Antennas—AutoRadio—Phonograph Pick-ups—Public Address Systems—Aircraft and Marine Radio—Radio Compass—Beacons—Automatic Radio Alarms—Short Wave—Coil Calculations—Testing—Cathode Ray Oscillographs—Static Eliminations—Trouble Pointers—Underwriter's standards—Units and tables. **REVIEW QUESTIONS—READY Reference Index.**

38 BIG CHAPTERS

Easy to Read - Easy to Grasp - Easy to Apply

A home-study course—especially well organized. The style is so interesting you will read along without effort, hardly realizing that you are actually studying and taking in vital information. Audels Radiomans Guide gives you just the right amount of mathematics required to cope with radio problems successfully. You can solve, with the aid of this extraordinary book, practically every radioproblem that comes up. At your finger tips is a complete index for instant use.



7 DAYS' FREE TRIAL

THEO. AUDEL & CO., Publishers
49 West 23rd Street, New York 10, N. Y.

\$4 COMPLETE \$1 PAY ONLY 1 MO.

Mail AUDELS NEW RADIOMANS GUIDE for free examination. If O. K. I will send you \$1 in 7 days; then remit \$1 monthly until \$4 is paid. Otherwise I will return it.

Name _____
Address _____
Occupation _____
Reference _____

MAIL THIS COUPON TODAY

CORRECTION NOTICE

Due to a typographical error the
advertisement,

LEEDS RADIO CO.

Page 580

should be corrected as follows:

BC-603 Tank Receiver . . . Price \$25.00

NOT \$5 AS PRINTED

RADIO-CRAFT MAGAZINE

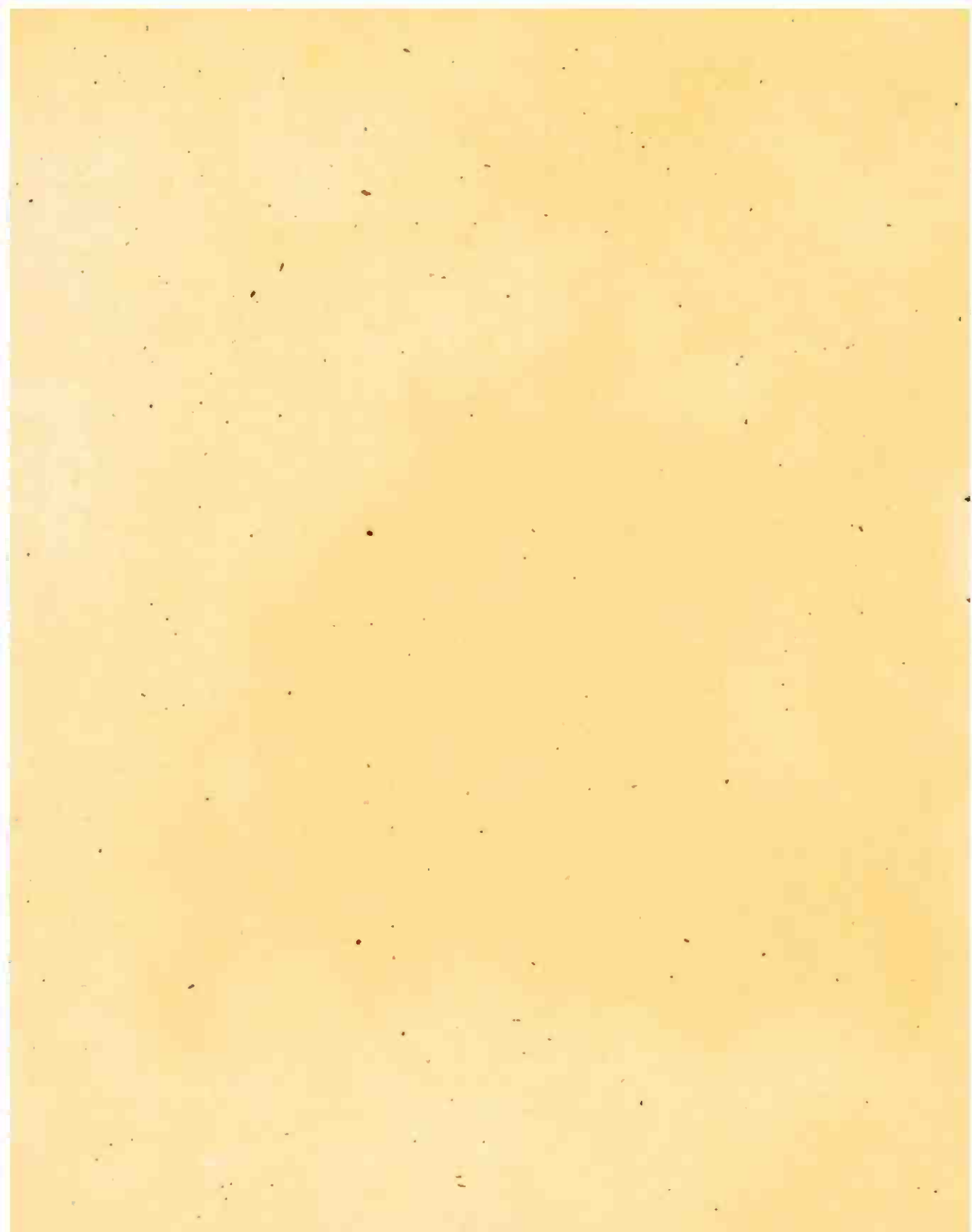

Radio Thirty-Five Years Ago

In Gernsback Publications

HUGO GERNSBACK

Founder

Modern Electrics	1908
Electrical Experimenter	1913
Radio News	1919
Science & Invention	1920
Radio-Craft	1929
Short-Wave Craft	1930
Wireless Association of America	1908

Some of the larger libraries in the country still have copies of Modern Electrics on file for interested readers.

From the May, 1911, issue of MODERN

ELECTRICS:

- Eiffel Tower and Time Signals.
- Wireless Efficiency Test.
- Rotary Spark Gap.
- A Silicon Ticker, by *Stanley Hyde*.
- Three Slide Tuner, by *William S. Wilder*.
- Foot-Operated Aerial Switch, by *Clift R. Richards, Jr.*
- Aerial Mast, by *John W. Gundy*.
- Tuning Coil for Fine Adjustment, by *Harold Hermann*.
- Plate Glass Condenser, by *Ethan Clarke*.
- A Simple Loose Coupler Frame, by *F. W. Doty*.
- Universal Detector, by *Edward Hutchinson*.
- A Break Key, by *Dick Cuthbert*.
- Mounting Crystals, by *Chester W. Scherf*.
- A Detector Switch, by *Walter Frost*.
- A Ground Block for Wireless, by *R. S. Crawford*.
- An Experimental Wireless Telephone, by *H. W. H.*
- Adjustable Condenser—for Sending Only, by *Jay Jakowsky*.
- A Silicon Detector, by *Clarence Ballard*.
- Watch-Case Wireless Outfit, by *William Dettmer*.
- Multiple Detector Stand.
- Wireless Across the U. S., by *E. A. Mayne*.

?? WHY NOT ??

Have you ever asked yourself, "Why can't I have this or that gadget on a radio? Why aren't programs made to fill such and such a need?" If so, you are a charter member of the Radio-Craft "Why Not" club. Send us your "Why Not's" on all subjects—serious or screwball, practical or idealistic. We will pay \$1.00 for every one we believe will interest the readers of Radio-Craft. You can get the idea from the "Why Not's" printed below. Send in as many as you like. One dollar will be paid for each one printed.

Why not put covers on all trimmer condensers with a special keyed device for opening so that only the serviceman could open it. This would prevent the customer from "tightening those loose screws" when the radio stops playing.—*J. H. Meyer, Metairie, La.*

(Seriously, the "sealed-unit" idea may be developed by some receiver manufacturers, especially for the new ultra-midgents.—*Editor*)

Why not build all radios with built-in chassis brackets so they could be inverted on the bench without endangering parts or

RADIO-CRAFT for MAY, 1946



PROOF CONVERTS A DOUBTER

We admit that our advertising of "VOMAX" describes the "one and only" . . . a v.t. multi-meter so new, so modern that it tops the list. Yet we know our each and every statement to be hard fact. Writes a converted "doubter":—

" . . . I would not part with VOMAX for any money . . . I read with considerable interest your articles in July and August 'QST,' 'Taming the Vacuum Tube Voltmeter.' Your claims as to this instrument's ability as a Dynamic Signal Tracer were taken with a grain of salt, however, because I had considerable experience using the vacuum-tube voltmeter as a signal tracer and in most cases results were far from satisfactory. I have used the 'VOMAX' as a signal tracer on several jobs and am more than pleased with the results . . . I was also pleased to find the instrument so stable and free of zero shift. This stability was another of your advertising claims which I took with a grain of salt. (Signed) A Satisfied Serviceman, Clarence F. Hartzell, Altoona, Penna."

If that isn't proof to the hardest boiled technician, may we mention "VOMAX" order and reorder by the U. S. Bureau of Standards? And as a clincher, you know that when your jobber is enthusiastic, it's because he has something of real value to you.

Say all eight New England stores of Hatry & Young; Radio-Wire-Television; Radio & Appliance Corp. of Nashville: "We and you, our customers, have waited a mighty long time for 'VOMAX'—it's more than we expected."

Say Radio Equipment Distributors, Los Angeles; Burstein-Applebee, Kansas City; Walker-Jimieson, Chicago; Mac's Radio Supply, Southgate, Calif.; Arrow Electronics, New York; Rhode Island Distributing Co., Pawtucket; Lew Bonn Co., Minneapolis and St. Paul; Wholesale Radio Laboratories, Council Bluffs; Terminal Radio, New York; Newark Electric of Chicago and New York; Lukko Sales, Chicago; "In our critical opinion these features establish 'VOMAX' as standard of comparison."

To tie the knot of acceptance and superiority even tighter, Bendix is now recommending "VOMAX" to all BENDIX RADIO distributors and dealers to insure top-flight service.

Your favorite jobber can probably squeeze your "VOMAX" out of his monthly allotment—if you act fast . . . while it's still only \$59.85 net.

Send postcard for complete specifications of "VOMAX," new 904 Capacitance-Resistance Bridge, 905 "SPARK" and other new, post-war, SILVER measurement and communication products. See them at the Chicago Trade Show, May 13 through 16.

OVER 34 YEARS OF RADIO ENGINEERING ACHIEVEMENT

McMurdo Silver Company
1208 MAIN STREET, HARTFORD 2, CONNECTICUT

making tuning impossible. There is room for them in most cabinets—cost would be small, and they could be used as a support for loops, etc., if an excuse for them is necessary.—*Charles McCleskey, Jr., Baton Rouge, La.*

(Some Signal Corps equipment was manufactured with this feature during the war.—*Editor*)

Why not have a pickup and mike in one? When used as a mike, it could be held in the hand and when used as a pickup, it could fit into brackets. The top part of the pickup could have a screen on it the same as an ordinary mike, while the bottom could be made just as the regular phono pickups are made. A switching arrangement could be provided to shut off the mike or

phono when one or the other is in use, so that extraneous noises would not be picked up.

JOHN WILLEY,
Montpelier, Vermont

Why not design a universal radio receiver with plug-in power supplies which can be purchased with this "single model" receiver? Five different types of power supply could be purchased; a dry-battery supply; a vibrator supply to be used with a 6- or 12-volt storage battery or 32-volt farm unit; an a.c.-d.c. supply for 117-volts; a supply for 110-220 volts at 60 cycles; and a supply for 110-220 volts at 25 cycles.

PVT. JOHN R. SIMPSON,
Ft. Meade, Md.



The Question Box is again undertaking to answer a limited number of questions. Queries will be answered by mail and those of general interest will be printed in the magazine. A fee of 50c will be charged for simple questions requiring no schematics. Write for estimate on such questions as may require diagrams or considerable research.

REPLACING THE 183 TUBE

? I have a Sparton receiver using push pull 183 tubes in the power amplifier stage. I would like to replace these tubes with some more common type. Please advise what tubes to use and what changes are to be made in the set. —J.J.M., Buffalo, N. Y.

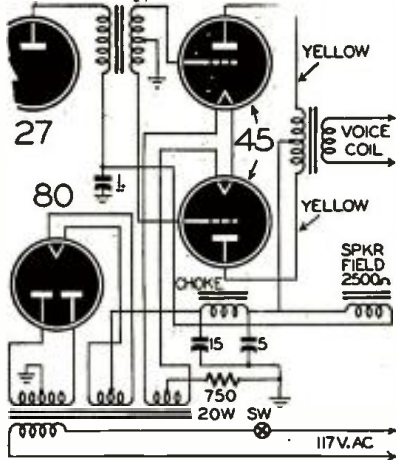

How Sparton 183's can be replaced with 45's. **▲.** The 183's may be replaced by a pair of 45's. Since the 45's operate with 2.5 volts on the filament of each tube, it is necessary to connect the filaments in series to make them work from the 5 volt filament winding that was used by the 183's.

The present cathode bias resistor will

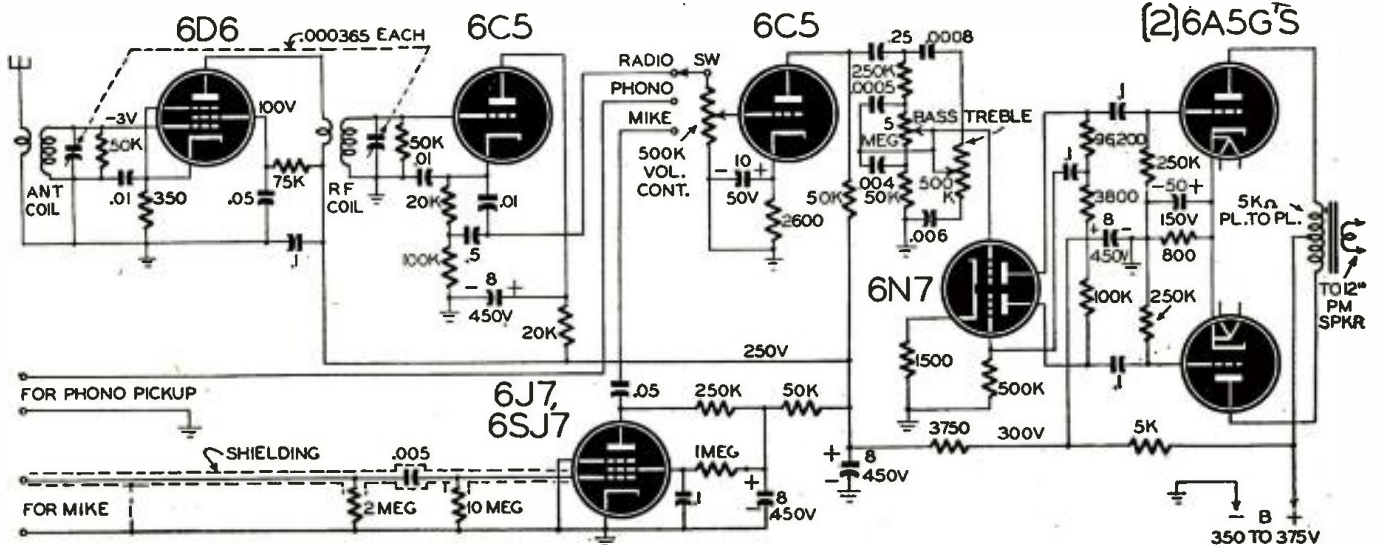

have to be replaced by a 750-ohm, 20-watt, wire-wound resistor.

The same sockets and output transformer may be used.

HI-FI TUNER-AMPLIFIER

? I would like a diagram of a two stage r.f. tuner working into a hi-fi amplifier with 6A5-G tubes in the output. The amplifier is to have microphone and phono input circuits. —J.A.J. —Goldsboro, N. C.

▲. The tuner uses a 6D6 as a t.r.f. stage feeding a 6C5 detector. It is designed for local reception and is not sensitive enough for distant reception.

A 6C5 is used as first a.f. stage and works directly from a phono pickup or the tuner. A 6J7 is used as a preamplifier for the microphone. Dual tone controls are incorporated in the grid circuit of the 6N7 phase inverter.

A signal of 2 volts (peak) is required on the grid of the 6N7 for full output. It may be necessary to change the tone control somewhat if the voltage is low on the grid. Instead of changing the tone control, another 6C5 may be inserted just ahead of the first a.f. stage.

The plate-to-cathode voltage of the 6A5 is 325 volts and for full output, the output of the power supply should be 375 volts. Low-resistance chokes and

heavy-duty power transformer should be used. The circuit is shown below.

ELECTRONIC METRONOME

? I would like to see a diagram of an electronic metronome that would be suitable for timing purposes and that could be varied easily in the number of beats per second or minute. —F.B., Detroit, Mich.

▲. The diagram shown should meet your requirements. It is essentially a multivibrator or relaxation oscillator and the beats may be made to vary from twenty per minute to above 100 kc depending upon the circuit constants.

It is obvious that if the beat-rate is more than a few beats per second, they will appear as one continuous tone and

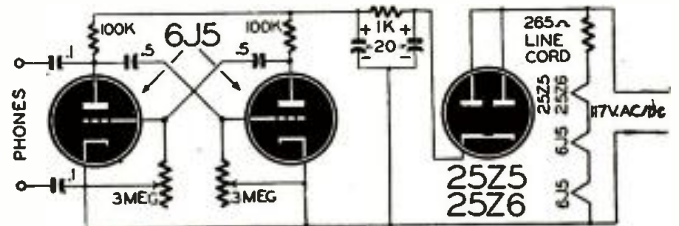

Widely varying frequencies can be produced by the multivibrator.

then the device may be used as a code practice oscillator by keying the cathode circuit of one of the tubes.

High impedance headphones are connected as shown in the circuit and the output of the device may be fed into an amplifier by placing the amplifier input plug into the metronome phone jack.

RADIO INDUSTRY UNFAIR?

(Continued from page 529)

is it to the ex-serviceman to obtain a dealership or an agency *on paper* if he cannot get the sets? As this is written at the end of March there is only a single, solitary radio set manufacturer in the U. S. who produces 100,000 units, i.e. (radio sets), per month. It should be remembered that before the war a normal month's production in radio sets ran at least into 1,141,600 units*. From this it will be seen that a mere 100,000 sets, the top production by any one maker at the present time, is a drop in the ocean. Right now radio sets simply are not being produced in pre-war numbers, let alone to fill post-war expectations.

As we go to press a statement by the president of the largest radio set manufacturer in the country, Philco, reaches us, from which we quote the following passages:

"But it is necessary to report that due to conditions beyond the control of the management of this or any other single company, our production remains at an unsatisfactory level and is much lower than our schedules called for. One of the chief bottlenecks at the present time is the fact that price ceilings on many radio parts and components are such that our suppliers are unable to provide us with more than a fraction of our requirements. A second major drawback has been a series of strikes in suppliers' plants which have also interrupted the flow of parts and hampered Philco production.

"The solution of these problems depends on the formulation of sound policies at the national level, and it is hoped that progress in this direction will soon be forthcoming."

The statement, signed by John Ballantyne, President, is dated March 12, 1946.

Other radio set manufacturers are in a like position. They have few, if any, sets at the present time. The late steel and other strikes did not make the already bad conditions better. Indeed, they caused further unexpected delays.

Our personal guess is that there will not be an abundance of radio sets in 1946.

We are certain that by the end of this year when the set manufacturers are getting into their full stride, and particularly when the new crop of set manufacturers begin to look for outlets in earnest, that the ex-serviceman, if he is at all deserving, will get his rightful share of the radio business.

The important point that we wish to make here is that the ex-serviceman should make himself thoroughly acquainted with ALL of the conditions prevailing in his industry. He cannot act intelligently until he has gathered all the facts. Believe us, there are many angles to be considered during the present hectic days.

*Nearly 14 million sets per year. In 1941 there were produced 13,700,000 units.

In this NEW WORLD OF ELECTRONICS—



NEW DEVELOPMENTS
SPELL *New Opportunities!*

A FEW YEARS AGO broadcasting was born—many of the first radiomen to enter that field have long since arrived at the top of their profession.

TODAY, the techniques of this New World of Electronics, war-developed and only now released, offer greater opportunities than ever existed in the early days of broadcasting!

MICRO-WAVE RELAY SYSTEMS, TELEVISION, FM broadcasting, mobile communication systems for trains, automobiles, busses and trucks, many industrial applications—these are only a few of the new developments and new techniques which offer marvelous, exciting opportunities to you who are alert—and are qualified!

YOU HAVE THE OPPORTUNITY to "get in on the ground floor"—where promotion will be rapid—where you can go to the top, IF—you have the foundation of technical knowledge which is so vital to an understanding of the new techniques. Your first step toward success in this new world of electronics is your resolution to acquire a formal, fundamental technical knowledge. CIRE courses of home study training are planned to do that job. Mail the coupon today!

CIRE HOME STUDY COURSES COVER THE FIELD OF RADIO-ELECTRONICS—TELEVISION, ULTRA-HIGH FREQUENCY TECHNIQUES, AM AND FM BROADCASTING, COMMUNICATIONS ENGINEERING—from simple treatment of fundamentals, through preparation for FCC commercial radio operators' license examinations, up to and including complete high level quantitative treatment of advanced radio-electronics and communications engineering. Choose the course best suited to your needs, and start with the section you are qualified to enter. You pay for only the section or sections you need. Use the "Pay-as-you-go plan" patterned after ethical, educational practice. These features are unique with Cleveland Institute, and represent the best in the modern, post-war concept of home study training.

Many CIRE students of advanced engineering courses today are broadcast chief engineers. Graduates of CIRE courses are eligible for the top jobs in radio-electronics.



Write today for free, descriptive booklet, "THIS NEW WORLD OF ELECTRONICS HOLDS OPPORTUNITY FOR YOU." No obligation—no salesmen.

CLEVELAND INSTITUTE of RADIO ELECTRONICS

Contractors to the Canadian Broadcasting Corporation.

Successors to

NILSON RADIO SCHOOL, Founded 1939

SMITH PRACTICAL RADIO INSTITUTE, Founded 1934

RC-5 TERMINAL TOWER - - - - CLEVELAND 13, OHIO

MAIL THIS COUPON.

CLEVELAND INSTITUTE of RADIO ELECTRONICS

RC-5 Terminal Tower, Cleveland 13, Ohio

Gentlemen: Please send information about your home study courses in Radio-Electronics.

NAME

ADDRESS

CITY

ZONE STATE

I desire training in

I have had experience in broadcasting servicing operating
mfg. CAA Army-Navy
amateur other

I am a High School Grad
College Grad

I hold a degree in

FOR EVERYTHING IN RADIO

WRITE

Leo, W9GFQ

For Fast Delivery!



Get Leo's own personal, sudden service on your radio and electronic needs. Quick delivery, lowest prices, liberal trade-in allowances.

SERVICE DEALER NEEDS



WRL MULTITESTER
Steel case with 30-60% angle. Cat. No. 16-491. Less Leads... **\$1875**

Handles AC DC Voltmeter, DO Milliammeter, high and low range Ohmmeter, 3" meter with sturdy D'Aronson movement. Size 5 1/2 x 8 x 3 1/4.

A complete stock of tools, replacement parts, test equipment, intercom and public address systems... everything for the progressive service dealer.

FOR EXPERIMENTERS

PHONO AMPLIFIER KITS

Complete with tubes, speaker, stamped chassis, and all resistors and condensers. Cat. No. 7-271... \$9.50 ea. Lots of 3, ea. **\$915**

Crystal sets, Antenna Kits, Code Oscillator Kits, Transmitter Kits, and many other items for the experimenter and radio enthusiast.

HAM NEEDS

Transmitting tubes, condensers, miles... everything for the Ham. One of the country's largest stocks of Ham equipment. Write Leo, W9GFQ, today, and be first with the latest. We invite inquiries for special equipment of all kinds.

TRANSMITTERS

For peak performance and more dollar for dollar value, get a WRL Transmitter Kit... designed in Leo's own laboratories... tested and proven. Available in 15, 35, 70, and 150 watt kits as well as kits custom built to your own specs. Write Leo today for complete details, prices and terms.

RECEIVERS

Here are just a few of the many well-known receivers offered by Leo:

Hallcrafters SX-25	\$ 94.50
Hallcrafters S-20R	\$ 60.00
Hallcrafters SX-28A	\$223.00
Echophone EC-1A	\$ 29.50
Hammarlund HQ-129X	\$129.00
National NC-2-40C	\$225.00

Write for details of our trade-in plan and easy terms.

FREE! 52 PAGE FLYER

52 pages packed with real buys in radio, electronic, and general merchandise.

Giant Radio Map (size 3 1/2" x 4 1/2").....15c
Handy Tube-Base Calculator25c

Address Dept. RC-5
Council Bluffs, Iowa



Formerly Wholesale Radio Laboratories

CLAMPING CIRCUITS

(Continued from page 542)

vent high (plate) voltage being applied to the sensitive plates of the cathode-ray tube. But when the signal passes through such an isolating condenser, the signal loses its d.c. component and the reference axis immediately becomes zero.

Unless a new reference level is provided—by a suitable circuit—the signal will shift of its own accord so that the zero reference (or time base) appears through the average center of the wave. That is to say, with the d.c. component gone, the area of the wave above and below the base line becomes equal. This is an inherent characteristic of most cathode-ray oscilloscopes.

To supply a new reference level, a clamping circuit is inserted between the coupling condenser and the deflection plates of the cathode-ray tube.

In a typical radar indicator circuit (Fig. 8), a diode D1 is used to clamp the positive extremities of the signal to a given reference level. All target or other indications on the tube will appear as downward deflections with respect to the reference axis.

During the time negative portions of the original signal are passing through the clamping circuit, diode D1 does not function. When positive portions of the signal are applied to the circuit, the diode conducts, acting as a short circuit. Charge on the condenser C1 maintains a balanced clamping circuit. In this way a d.c. component of the wave is restored or re-established.

Another diode D2 is used in the radar indicator circuit of Fig. 8. Second diode is used to clamp voltage impulses applied to the grid of the cathode-ray tube. These are known as *brilliance pulses*, and are miniature (power) versions of the original signal. Applied to the grid of the oscilloscope, these pulses cause the tube to become bright or brilliant *only* during periods when a signal is actually being received and is being applied to the deflection plates. Such brilliance pulses might ruin the tube unless restricted in voltage so that the peaks never exceeded a certain, safe, reference level. Purpose of the diode D2 is to supply this needed restriction in combination with the long time constant (RC) composed of condenser C2 and resistor R2. Operation is identical to the positive clamping circuits described earlier.

Clamping also makes possible the application of *two signals* to a single cathode-ray tube: one signal above the oscilloscope base line, the second signal below. Thus, two phenomena can be viewed and compared at the same time. Without clamping action on each of the two signals, they would merely vary about the oscilloscope base line (zero reference) and prevent an examination

of their relative amplitudes and wave shapes.

Clamping is also used in the sweep or time base circuits of cathode-ray oscilloscopes. If co-phased sweep voltages don't always start from the same reference point (in time), the resultant trace will not begin at the same place on the scope screen each time a cycle is repeated. Result would be a jittery and quite erratic trace. Use of a clamping circuit—between the final amplifier and the deflection plates of the tube—permits easy regulation of the start of the sweep trigger voltages.

Often clamping is used for both the signal and the sweep voltages of cathode ray oscilloscopes. This is of particular importance in many radar circuits to ensure complete independence of signal and time base shift.

Clamping permits the elimination of

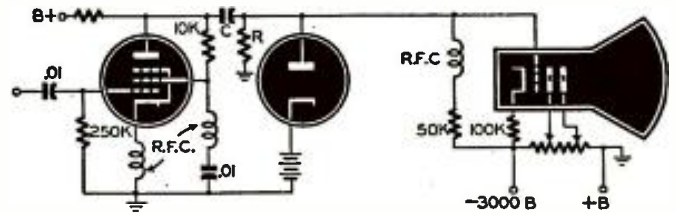

Fig. 9—This television output system uses a peak clamping diode.

low-frequency portions of extremely complex wave shapes—such as are encountered in video stages of television circuits. These low frequencies are not particularly desirable, and the final television picture will not suffer appreciably by their loss.

Clamping circuits are also used in television to hold blanking at a fixed potential—generally at the control electrode of the picture-tube. One typical

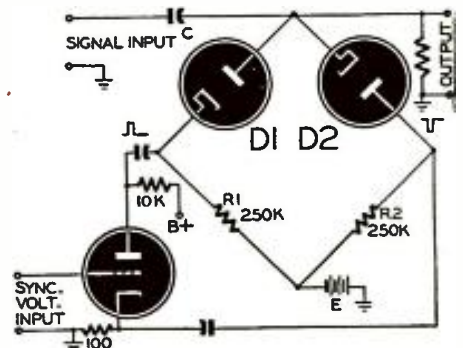

Fig. 10—Synchronized bridge clamping circuit.

arrangement is shown in Fig. 9. Values of condenser C and resistor R have a 1μ time constant compared with the line-scanning interval. But the product RC will be short when compared to the duration of changes in background light.

The biased diode (Fig. 9) with condenser C and resistor R develops a voltage reference level equal to the peak of the video signal. Since the peak value is fixed, camera-signal components of the video wave act in series with a fixed bias—forming part of the control-elec-

trode bias on the grid of the cathode-ray tube. Background brightness of a televised scene thus depends only on the average value of the camera-signal component. The blanking level remains fixed.

Supersync can also be held to a fixed point of amplification by means of a clamping circuit, thus establishing a stable black-level independent of amplifier saturation.

SYNCHRONIZED CLAMPING

All of the clamping circuits previously described used a diode or triode to clamp either amplitude extreme—and allow the wave form to extend in only one direction from the reference level.

A third and distinct class of clamping is known as *synchronized clamping*. This circuit maintains the output potential at a fixed level until an external synchronizing wave is applied, when the output voltage is allowed to follow the input signal. Then, at the conclusion of the synchronizing wave the output voltage is returned immediately to the reference level. This system is used in most television circuits.

Simplest type of synchronized clamping uses a pair of diodes in a Wheatstone or balanced bridge circuit (Fig. 10). Other two arms of the bridge consist of equal resistances.

The input signal to be clamped is applied to the upper junction between plate and cathode of adjacent diodes. When a reference bias is required, this voltage E is applied to the diagonally opposite junction of the bridge.

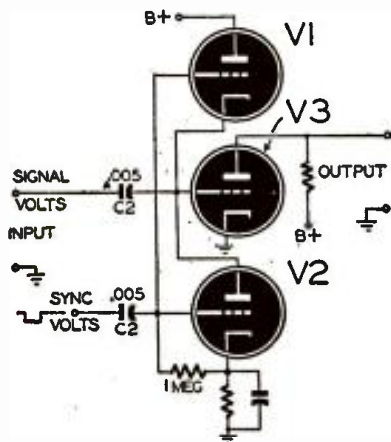

Fig. 11—Synchronized clamping, another form.

The synchronizing voltage (generally a rectangular wave) is first applied to a low-gain triode amplifier, and the output of this tube is connected to one junction of the balanced bridge. A direct connection is also made between the sync wave and the remaining junction point. In this way, the sync wave is applied in opposite phase to opposite junctions of the bridge circuit.

When a sync is applied to this circuit (Fig. 10), the co-phased outputs from the triode prevent the two diodes from conducting. A positive voltage is applied to the cathode of diode D1; a negative voltage is applied to the plate of diode D2. Thus the clamping circuit is inactive, and the upper junction of the bridge unaffected. Consequently, the input signal appears across the output

without change in reference level.

When the rectangular sync is released, the clamping circuit immediately becomes active.

Reversal of polarity of the sync wave applies a negative voltage to the cathode of diode D1 and a positive voltage to the plate of diode D2. The two diodes conduct. The bridge is balanced, because of the symmetry of the circuit elements. Therefore the bias voltage appearing at the lower junction also appears at the upper junction. In this manner the input signal is clamped to the reference voltage E while the bridge is active.

When the next rectangular sync wave is applied, the bridge again becomes non-conducting and the upper junction is free to follow the signal wave form, and the entire process is repeated, according to the nature of the sync wave applied to the circuit.

Co-phased sync waves are coupled to the bridge through blocking condensers. Each diode is shunted by its own resistor—R1 and R2—which charges the condensers so as to reduce the diode current flowing during conduction.

During the clamping period, if a charge develops on the condenser C it is removed through the diodes. If the charge produces a positive potential at the output, diode D1 provides a discharge path. If the charge is of opposite sign, diode D2 provides a discharge path. Both of these paths are of low impedance, necessary for a rapid discharge of condenser C.

Another form of synchronized clamping utilizes two control triodes in a voltage divider circuit (Fig. 11). Triodes V1 and V2 act as variable resistors. This arrangement maintains a constant bias on tube V3 at all times except when a negative-going sync wave is applied to the clamping circuit.

When the sync wave is not applied, the input signal feeds directly to the grid of tube V3. Except for a small fixed bias, the voltage at the grid of tube V3 and the cathode-to-plate voltage across tube V2 are identical. Any positive increase in a signal voltage results in an increase in the bias of V1—which makes it a much higher resistance, and brings the voltage at the plate of V2 (and the grid of V3) back to normal. In a similar manner, a decrease in the grid voltage of V3 results in a decrease in the bias of V1, which decreases the effective resistance of that tube and brings the voltage at the grid of V3 back to normal. Action of V1 and V2 thus maintain the grid voltage of V3 at a constant value.

When a negative rectangular sync wave is applied to the clamping circuit (Fig. 11), tubes V1 and V2 are driven beyond cut-off for the duration of the sync wave. When these tubes are not conducting, the grid of tube V3 is left free to follow any changes in amplitude of the input signal. Condenser C1 cannot discharge. Thus the grid voltage of V3 follows the input signal voltage.

At the end of the sync wave, tubes V1 and V2 are permitted to conduct, returning the voltage at the grid of V3 to the reference level, and the clamping process is repeated.

Highest Quality RADIO & ELECTRONIC TESTING EQUIPMENT

IMMEDIATE DELIVERY from STOCK GUARANTEED



The New Superior
Model CA-11
Signal Tracer
Net Price \$18.75

FEATURES:

- ★ Signal intensity readings are indicated directly on the meter.
- ★ Only one connecting cable—No tuning controls.
- ★ Highly sensitive—uses an improved vacuum tube voltmeter circuit.
- ★ Tube and resistor-capacity network are built into the Detector Probe.
- ★ Completely portable — weighs 5 lbs. Measures 6 x 6 x 7 inches.
- ★ Provision is made for insertion of phocons.

The New
SUPERIOR
Model
PB-100
Volt-Ohm-
Milliammeter
Net Price
\$28.40

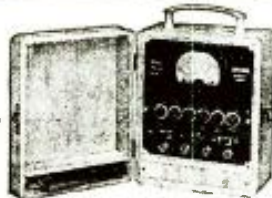

Ranges:
DC Volts: 0 to 5/25/50/250/500/2500
AC Volts: 0 to 10/50/100/500/1000
Output Meter Ranges: 0 to 10/50/100/500/1000 volts
DC Current: 0 to 10/250 ma. 0 to 2.5 Amp.
Resistance: 0 to 10,000/100,000 ohms. 0-1 Meg.
Decibels: -10 to +15; 0 to +25; +30 to +55.



The
New "MONITOR"
Crystalline
SIGNAL
GENERATOR
Net Price \$57.50

A New Type Signal Generator designed for the Serviceman interested in money-making ideas. Finger-Tip Control. Frequency instantly selected. No confused dial to read. No band switch. I.F., Broadcast, Shortwave and Ultra High Frequencies with or without 400 cycle note. Frequency accurate to .1 of 1%. Output approximately 10 volts.

The New Model 802N
Combination
TUBE & SET
TESTER



Net Price \$58.31

RANGES:

DC Voltmeter: 0/10/50/500/1000 at 1000 ohms per volt
Four Range AC Voltmeter: 0/10/50/500/1000
DC Milliammeter: 0/1/10/1000 DC Ammeter 0/10
DB Meter: -8/15/15 to 29/29/ to 49/32 to 55 decibels
Four Range Output Meter—same as AC Volts

R.C.P. Model 447 AC-DC Multitester	\$17.59
R.C.P. Model 448 Pocket Multitester	24.01
R.C.P. Model 461A Sensitive Multitester	38.71
I.L.C.P. Model 488 Ultra-Sensitive Multitester	70.07
I.L.C.P. Model 668 Electronic Voltmeter	73.01
R.C.P. Model 805 Tube & Set Tester	87.71
Supreme Model 546 Oscilloscope	82.50
McMurdo Silver Model 900 "Vomax"	59.85
SUPERIOR Model 1553 Volt Ohm Milliammeter	24.75
SUPERIOR Model PB-210 Multi Meter	35.75
SUPERIOR Model 450 Tube Tester	39.50
SUPERIOR Model 720 Multi-Range AC Ammeter	49.50
SUPERIOR Model 400 Electronic Multimeter	52.50

Send for our FREE New Post-War Catalog!

Metropolitan

ELECTRONIC & INSTRUMENT CO.

Dept. G, 6 MURRAY STREET

NEW YORK 7, N. Y., U. S. A.

Phone: BARclay 7-5556

Cable Address: METRONICS

NEW RADIO PATENTS

By I. QUEEN



These Aerovox Type PBS cardboard-case electrolytics squeeze into the tightest places because they mount three ways—perfectly flat, on the side, or on end.

Aerovox Adjustimount feature facilitates the mounting of single or stacked units. Slotted metal mounting bracket instantly adjusted to any situation.

PBS electrolytics are available in wide range of popular voltages, capacitances, combinations.

Ask Our Jobber . . .

Ask for Aerovox Type PBS cardboard-case electrolytics as handy general-purpose replacement units. Ask for new postwar catalog. Or write us direct.



FOR RADIO-ELECTRONIC AND INDUSTRIAL APPLICATIONS

AEROVOX CORP., NEW BEDFORD, MASS., U.S.A.
Export: 13 E. 40th St., New York 16, N.Y. • Cable: 'ARLAB'
In Canada: AEROVOX CANADA LTD., Hamilton, Ont.

VOLTAGE DOUBLER

William W. Garstang, Indianapolis, Ind.
Patent No. 2,392,472

THIS vibrator uses two sets of contacts which enable it to double the voltage of the battery which energizes it.

Initially the armature rests on the three lower contacts and when the battery is switched on current flows through the magnet winding. This attracts the armature which therefore touches the upper contacts and interrupts the battery charges the condenser to its full voltage.

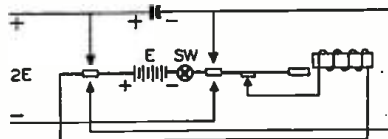

As the magnet is no longer energized the armature falls back upon the lower contacts again. This puts the condenser in series with the battery with the proper polarity so that a total voltage of 2E exists across the output terminals. An interrupted voltage of this peak value exists as long as the vibration takes place.

ENERGY REFLECTOR

Raymond J. McElhannon, Flushing, N. Y.
Patent No. 2,391,914

FOR radar and similar applications of microwaves, radio energy is emitted through wave guides and caused to scan a given area. This usually requires a mechanical motion. This invention, however, makes use of electronic means to direct radio waves.

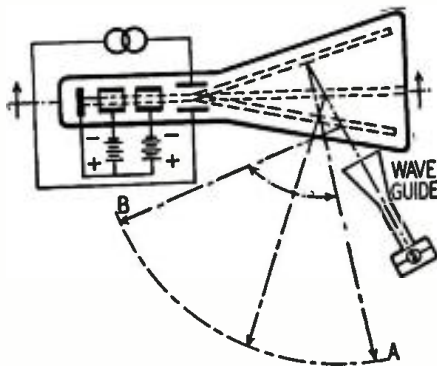

An elongated oscilloscope tube is used to provide a sheet of electrons. This tube is much wider than its height. Starting from the base end, the tube contains a cathode or filament, two focusing electrodes and a set of deflecting plates. An electron sheet is thus emitted by the filament and is deflected between the two extreme positions noted by the dotted lines.

The energy output of a wave guide is directed against the electron sheet and since the latter has the properties of a conductor, reflection takes place as shown, between the extreme positions A and B. A more complicated set-up may be used if it is required that reflection of the energy takes place in more than one plane.

PILOT LAMP

Chalmers Morehead, E. Orange, N. J.
Patent No. 2,392,333

THIS device combines the features of fluorescent and glow lamps in one bulb. It can be used either for decorative purposes or for pilot bulb use. Its advantages are low power dissipation, cooler operation and long life.

The bulb is filled with an inert gas such as argon at low pressure. The leads are mounted through a glass seal, and at their inner ends are spot welded two filament coils. The junction

of these coils is further supported by the seal.

When a low voltage is applied to the bulb, the filament becomes heated. At about 10 volts a glow discharge also takes place between the main lead ends, and the bulb then glows brightly. The full current of the bulb is .15 amperes.

Fluorescent material may be coated on the inside of the bulb in order to obtain any desired color including ultra-violet radiation. If a string of these bulbs are connected in series and one becomes defective by reason of failure to glow, the other bulbs will continue to function.

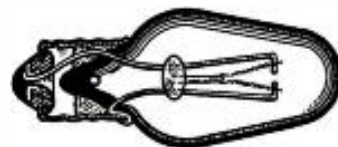

MOTION INDICATOR

Herbert Ziebolz, Chicago, Ill.
Patent No. 2,383,758

MOTION or position is translated into electrical signals by means of an oscilloscope. The electron stream of the tube is deflected by both static and magnetic fields. Therefore the position of a magnet will affect the direction of the electron beam and the point at which it strikes the plate. If only part of the spot hits the plate, the meter will read lower than if the plate catches all the electrons.

Coil L1, together with its variable shunt, is used to counteract the effect of the magnet. Curve A is the result when the shunt is approximately 1/5 the resistance of the coil. Curve B is obtained when the two are equal. L2 is used to position the spot initially so that it strikes the center of the plate.

One application of this invention is the indication of the height of a liquid in a pipe by means of a floating magnet on the surface.

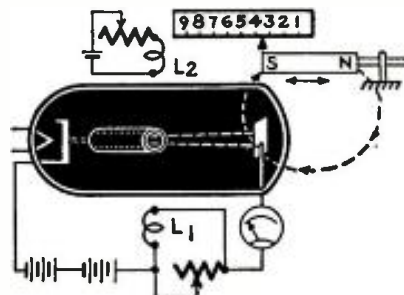

BRITISH HAMS ARE BACK

British amateurs are now back on the air, and licenses are being issued to operators and stations. Some dissatisfaction is reported at the slowness with which licenses are being processed.

As in the United States, a great increase in the number of "hams" is noted. Membership of the Radio Society of Great Britain has jumped from 2,000 before the war to over 4,000, and it is expected that with radio-minded ex-Servicemen membership will reach 10,000 before the end of 1946.

RADIO EQUIPMENT SHOW

Postwar radio parts and electronic equipment will be exhibited to the public in a national radio show to be held in the Stevens Hotel, Chicago, May 13th to 16th. It is expected that many entirely new items will appear.

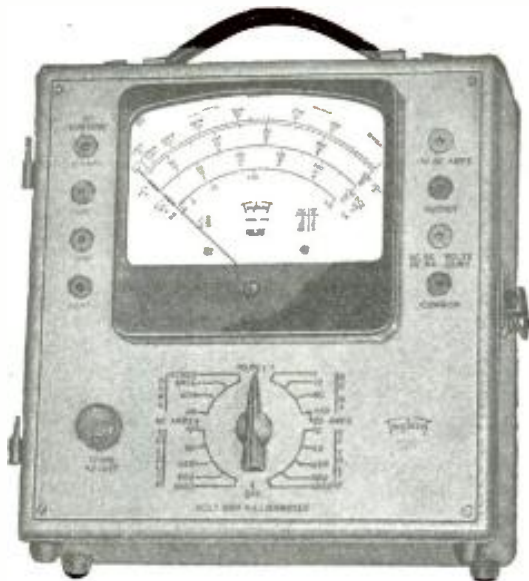

MODEL 2405

Volt·Ohm·Milliammeter

25,000 OHMS PER VOLT D.C.



SPECIFICATIONS

NEW "SQUARE LINE" metal case, attractive tan "hammered" baked-on enamel, brown trim.

■ **PLUG-IN RECTIFIER**—replacement in case of overloading is as simple as changing radio tube.

■ **READABILITY**—the most readable of all Volt-Ohm-Milliammeter scales—5.6 inches long at top arc.

■ **RED·DOT LIFETIME GUARANTEE** on 6" instrument protects against defects in workmanship and material.

NEW ENGINEERING • NEW DESIGN • NEW RANGES 30 RANGES

Voltage: 5 D.C. 0-10-50-250-500-1000 at 25000 ohms per volt.

5 A.C. 0-10-50-250-500-1000 at 1000 ohms per volt.

Current: 4 A.C. 0-.5-1-5-10 amp.

6 D.C. 0-50 microamperes—0-1-10-50-250 milliamperes—0-10 amperes.

4 Resistance 0-4000-40,000 ohms—4-40 megohms.

6 Decibel -10 to +15, +29, +43, +49, +55

Output Condenser in series with A.C. volt ranges.

Model 2400 is similar but has D.C. volts Ranges at 5000 ohms per volt.

Write for complete description

Triplet

ELECTRICAL INSTRUMENT CO.

BLUFFTON, OHIO.

SUPERAMP WITH TUNER

(Continued from page 539)

Noticeable is the .0004 mf mica condenser in series with the oscillator coil primary and ground, to assure more uniform band spread. The i.f. signal is amplified at 456 kc, through a 7A7, then detected by a double diode triode-7C6. One of the diodes is used to supply

a.v.c. voltage to the first stage. The radio volume control doubles as diode load. The a.f. signal from the triode plate of the 7C6 is coupled through a condenser and d.p.d.t. switch on back of the tuner volume control, to the 7C7 control grid. One half of the radio volume control switch is used to control a pilot light used to denote whether the tuner is in or out of the a.f. circuit.

Incorporated is a well filtered full-wave power supply, good for 300 volts at 150 milliamperes—the actual high voltage current drain being about 115 ma.

A complex power switch is used in order to control the phono motor, mounted on top of the cabinet. By

moving the power switch arm one position from the off position, power is applied only to the amplifier and tuner; by moving a position further, the arm applies power also to the phono motor. A third section of the power switch applies 6.3 volts to a pilot indicator.

OPPORTUNITY AD-LETS

Advertisements in this section cost 10 cents a word for each insertion. Name, address and initials must be included at the above rate. Cash should accompany all classified advertisements unless placed by an accredited advertising agency. No advertisement for less than ten words accepted. Ten percent discount six issues, twenty percent for twelve issues. Objectionable or misleading advertisements not accepted. Advertisements for June, 1946, issue must reach us not later than April 23, 1946. Radio-Craft • 25 W. 57th St. • New York 7, N. Y.

MAGAZINES (BACK DATED)—FOREIGN, DOMESTIC, arts, books, booklets, subscriptions, pin-ups, etc. Catalog 10c (refund). Clearone's, 863 First Ave., New York 17, N. Y.

AMATEUR RADIO LICENSES, COMPLETE CODE and theory preparation for passing amateur radio examinations. Home study and resident courses. American Radio Institute, 101 West 63rd Street, New York City. See our ad on page 588.

CORRESPONDENCE COURSES AND SELF-INSTRUCTION books, slightly used. Sold, Rented, Exchanged. All subjects. Satisfaction guaranteed. Cash paid for used courses. Complete information and 92-page illustrated bargain catalog free. Write—NELSON COMPANY, Dept. 2-39, Chicago 4.

SURPLUS RADIO AND ELECTRONIC PARTS AND equipment. New and used. Write for free list. Highbridge, 312 Canal St., New York City 13.

YOUR NEW FREE CATALOG IS READY! RADIONIC'S Catalog lists hard-to-get radio parts and books. All available for immediate shipment. Send today to: Radionic Equipment Co., Dept. N5, 170 Nassau St., New York 7, N. Y.

QSL'S, SWL'S NEW DESIGNS, FIRST CLASS PRINTING. Free samples. Richard Franzen, W3DEE, Maple Shade, New Jersey.

RADIO TUBES, PARTS WHOLESALER, BULLETIN 3c. Fenshaw Radio Co., 3313 Delavan, Kansas City, Kansas.

PLANS 1-TUBE DC RECEIVER (SW RECORD 7000 miles), including "Radiobuilder"—25c. Laboratories, Box 1-b, San Carlos, California.

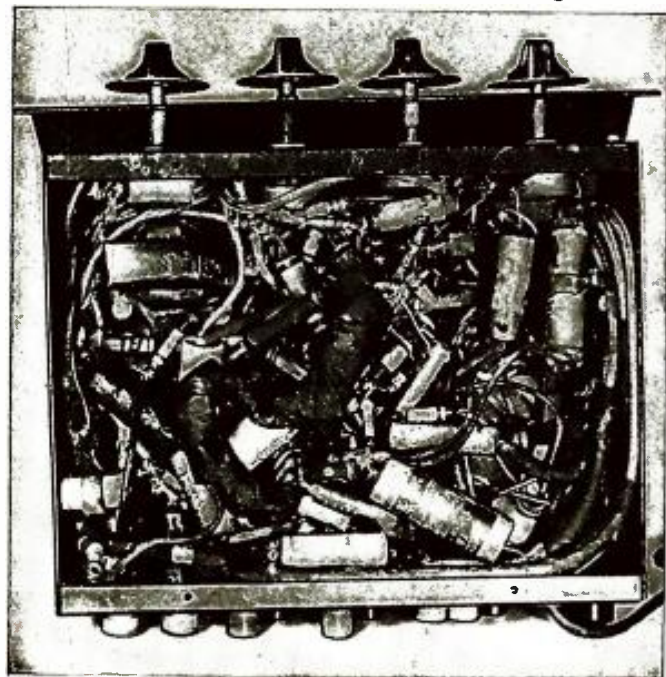

The under-chassis wiring is somewhat complicated due to the large number of parts.



**...here's a
TIP
for You!**

In fact there are four interchangeable tips adapted to the Ungar Soldering pencil... each designed to do speedy precision work on hard-to-reach jobs!

No. 537 Pencil Tip, made from Elkaloy A, Tip 1/8" dia.

Ruggedly built, the Ungar Soldering tool weighs only 3.6 ozs., is perfectly balanced and handles like a fountain pen. Heats in 90 seconds. Draws only 17 watts. Unit complete with any one tip sells at less than \$2. Please order from your Electronics distributor.

No. 538 Chisel Tip, made from Elkaloy A, Tip 1/8" dia.

No. 536 Standard Tip, made from Hard Drawn Copper

No. 539 Extra Hot, made from Tellurium

Ungar
Electric Tools, Inc.
Formerly Harry A. Ungar, Inc.
LOS ANGELES 54, CALIF.

MULTIPURPOSE TESTER
(Continued from page 534)

a receiver or amplifier. For tracing audio-frequency signals, connect a shielded test prod and lead to jack J7. The signal may then be traced from the sound source to the output by touching the prod to successive stage circuits. The r.f. test probe is used for following the signal from the aerial to the detector of a receiver. To operate, turn on switch Sw2, and connect a jumper wire from jack J7 to J6. The signal can then be observed or heard by touching the probe of the tube to the r.f. and i.f. stages. Always connect a lead from J8 to the chassis of the receiver whenever the signal tracer is used.

The volume control, R3, should be turned up about halfway for the average signal. The electron-ray indicator tube can be used to observe the intensity of the signal. The tube is turned on by switch Sw3, and connected to the amplifier by turning selector switch Sw4 to position 1. Turn up the intensity control R18 until the indicator tube responds to a signal impressed on the amplifier. Set the uncalibrated bias control R15 so that all of the resistance is cut out. This causes the "eye" to open.

The intensity of two or more signals may be accurately compared or matched with the indicator tube. With no signal present, turn the calibrated dial which operates R16 to 0 degrees (all resistance effective), and adjust the uncalibrated potentiometer R15 until the shadow angle is 0 degrees or the "eye" just barely closed. Turn the intensity control R18 to its maximum setting and do not change the setting during tests. Apply the signal to the unit and note that the green image will overlap. Turn the top calibrated dial R16 until the indicator tube appears just as it did with no signal present. Read the number of degrees indicated by the dial and then repeat the process for other signals. If the reading is less for another signal, the strength is less; if the reading is greater, the signal strength is greater.

To connect the test unit as a voltmeter, turn on the power supply and indicator circuit with the switch mounted on R3, and toggle switch

Sw3. Revolve the top calibrated dial (R16) to 0 degrees, and with R15, the uncalibrated control, adjust one section of the twin indicator tube until the "eye" just barely closes. Plug in the test leads to the red jack J1 and the black jack J2. For measuring d.c. voltages connect the lead from J1 to the positive side of the potential to be measured and the lead from J2 to the negative side. Turn the selector switch Sw4 to position 2. If the voltage is not great enough to cause the green image to overlap, switch to position 3, 4, or 5. After the proper range has been selected, rotate the top calibrated dial (R16) until the "eye" opens to the "just barely closed" position. Read the number of degrees indicated and refer to the proper voltage chart.

Two of these voltage charts should be made for each of the four ranges. One set is for a.c. and the other for d.c. voltages. These charts can easily be prepared by applying known voltages and recording the number of degrees deviation from zero required for each voltage. An accurate voltmeter used in conjunction with a variable a.c. and a variable d.c. source can satisfactorily be used to calibrate the tester.

If it is not known whether the voltage is a.c. or d.c., it can be determined by reversing the leads. If the voltage is d.c., the 6AF6-G tube will indicate the voltage only with the positive side connected to J1. If the voltage is a.c., the tube will indicate the potential during both trials.

Position 5 will measure 1 to 32 volts a.c. or .5 to 41 volts d.c.; position 4, 20 to 400 volts a.c. or 5 to 200 volts d.c.; position 3, 100 to 1100 volts a.c. or 50 to 600 volts d.c., and position 2, 400 to 2500 volts a.c. or 200 to 1500 volts d.c.

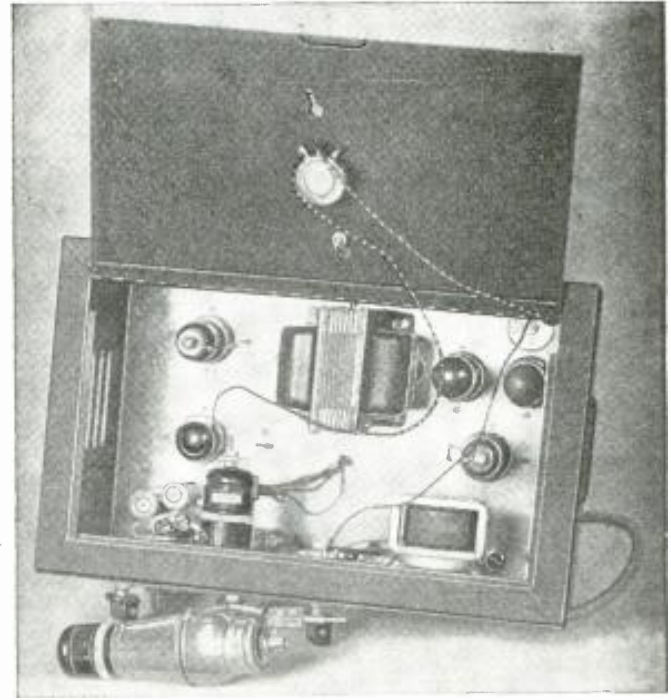

Components in the instrument are neatly and well laid out, as may readily be seen in the photograph, right.

Position 2 has a much higher theoretical range, but due to arcing or breaking down of the insulation in the selector switch or at the jacks, it is not advisable to apply higher voltages.

One of the leads is connected directly to the chassis; so, take care that the metal cabinet is on an insulated surface well away from the receiver or voltage source and that the operator does not touch the cabinet. It might be worthwhile to insulate the cabinet from the negative side of the "B" supply and to connect a small condenser from the negative side to the chassis.

CURRENT MEASUREMENTS

The test unit can be used for approximate current measurements in cases where the relatively high voltage drop will not upset the operation of the circuits. To set the tester for this function, the following steps should be taken. Turn on the power supply and

indicator circuit, revolve the top calibrated dial to 0 degrees, and with the uncalibrated knob set the indicator tube so that the green area of one section just barely touches. Turn selector switch Sw4 to position 7, and plug in the test leads to J1 and J3. Connect the prods in series with the circuit to be analyzed. For d.c. measurements make sure to connect the black lead from J2 so that as the electrons flow from negative to positive, they will enter that lead. Turn the selector switch to position 8 for large alternating or direct currents, or to position 9 or 10 for smaller direct currents. With current flowing through one of the shunt resistors, the image of the indicator tube should overlap. Adjust the top calibrated dial so that the image appears as it did with no current flow. Read the setting and refer to the proper current chart.

Two current charts are required for position 8 and one each for positions

9 and 10. The charts can be prepared very easily with the aid of variable a.c. and d.c. sources and accurate alternating and direct current meters. Position 8 has an a.c. range of 1 to .15 ampere or a d.c. range of 1 to .05 ampere. The current is limited to a maximum of 1 ampere because of the power rating of the resistor and the large voltage drop. Position 9 has a range of 20 to .5 milliamperes d.c. only; and position 10 has a range of 1200 to 50 microamperes d.c. only.

The current meter may be found useful for approximate measurements if no standard meter is on hand.

RESISTANCE MEASUREMENTS

The methods of connecting the low range ohmmeter circuit of the test unit is as follows: Turn on the power supply and indicator circuit, revolve the top calibrated dial to 0 degrees, and

(Continued on following page)

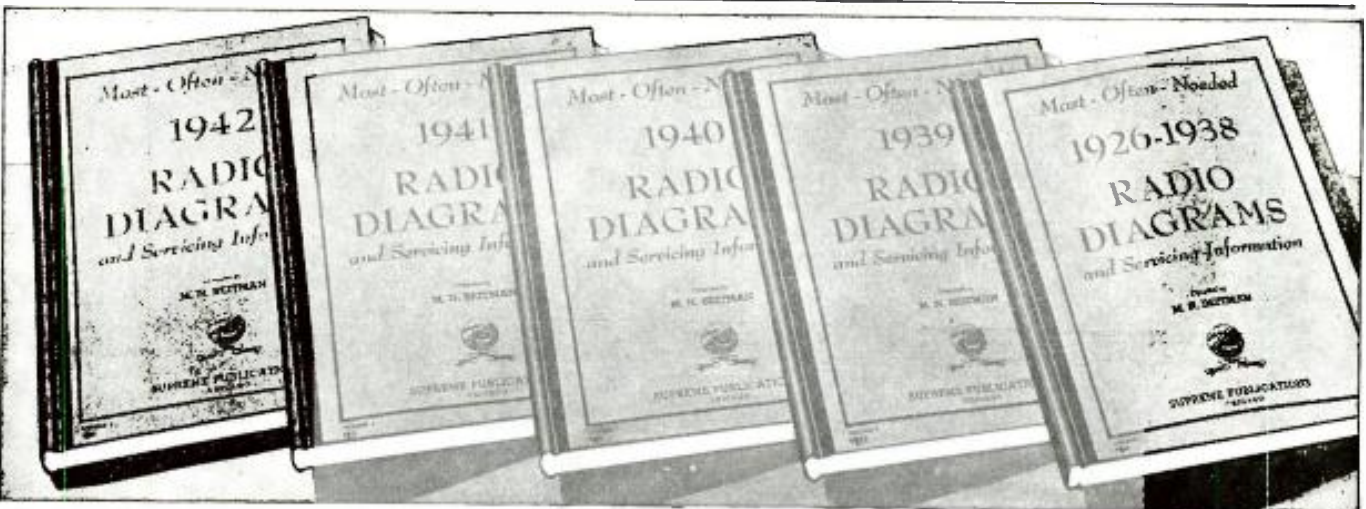

1942 4 OUT OF 5 DIAGRAMS YOU WILL EVER NEED

Find radio faults quickly. Make the needed repairs in any radio in minutes instead of hours. Save time on every job. These large, inexpensive diagram manuals have the circuit for every popular radio receiver. 4 out of 5 diagrams you will ever need are included.

WITH ALIGNMENT DATA, PARTS LISTS

Clearly printed circuits, alignment data, parts lists, service hints are the facts you need to speed up servicing. Repair radios quickly and properly—follow the factory instructions given in these manuals. The 1942 manual lists 351 models of 40 manufacturers. 192 fact packed pages. Large size, 8½ x 11 in. **\$2.00**

1926-1938

The most popular volume of the series. Will pay for itself with the time saved during the first day of use. Includes all the popular old timers. Save hours on every job. 427 diagrams of the most-serviced radios of this period, with parts lists and alignment information. 240 pages, 8½ x 11 inches. **\$2.50**

SAVE HOURS ON EVERY JOB

Be ready to make repairs in minutes instead of hours. You will be called upon to fix hundreds of models listed in these easy-to-use manuals. Tackle each job with the needed help found in these service manuals. Greatest bargain in diagram books. Send coupon today. Plan to use these manuals this week. →

Compiled by M. N. Beitman, radio engineer, teacher, author & serviceman.

POPULAR, LOW-PRICED DIAGRAM MANUALS

1941

These easy-to-apply, inexpensive manuals will help you repair radios faster. This volume covers 1941 models, with alignment data, I.F. peaks, and replacement parts lists. Compiled by M. N. Beitman, radio serviceman for many years, author and teacher. Be expert in radio servicing; simplify your work. 192 pages, 8½ x 11 inches. Only **\$2.00**



1940

Let this important manual give you over 80% of all 1940 circuits you will ever need, acquaint you quickly and efficiently millions of sets. Data on F.M., portables, recording, etc. 417 models of 43 manufacturers. 208 pages. Net price **\$2.00**

1939

Another handy manual of most-popular diagrams you need. Circuit data, hints, and information are time-savers and money-makers for you. Let these diagram manuals guide you to easier service work. Why try to get along without helpful diagrams? Use this volume with 192 pages of popular diagrams of 39 manufacturers. Order today. Price only **\$2.00**

Most Popular Models Made by:

- Philco, RCA, Zenith, Sears, GE, Emerson, Belmont Radio, Detrola, Pada, United Motors, Westinghouse, Arvin, Majestic, Stewart-Warner, Admiral, Delco, Stromberg-Carlson, Western-Auto, Sparton, Wards, Motorola, Gamble, and many others.

NO RISK TRIAL ORDER COUPON

SUPREME PUBLICATIONS, 9 S. Kedzie Ave., Chicago 12, ILL.

Ship the following diagram manuals: (Money back guaranteed)
 1942 1941 1940 1939 1926-1938

- I am enclosing \$..... send postpaid.
- Send C.O.D. I am enclosing \$..... deposit.

Name:

Address:

(Use Coupon or Write Order in a Letter)

Supreme Publications

PUBLISHERS OF RADIO BOOKS, MANUALS, AND DIAGRAMS

SUPREME

TESTING INSTRUMENTS

AFTER A GREAT
WAR RECORD

BACK AGAIN!

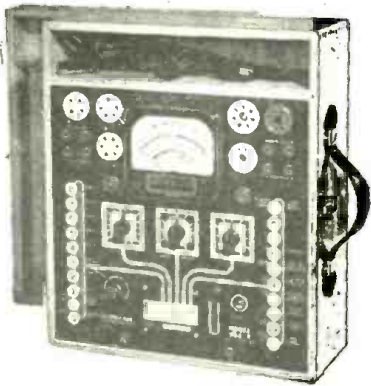

SUPREME MODEL 504-A TUBE AND SET TESTER

SUPREME regrets that war necessitated an interruption of service to its customers and friends. We are genuinely glad to get back into peacetime production—production for YOU.

MANY SUPREME INSTRUMENTS NOW AVAILABLE

—But not enough to take care of all orders at one time. Demand for accurate, dependable SUPREME equipment is such that we suggest you make arrangements for your needed new SUPREME models without delay.

SEE YOUR NEAREST SUPREME
JOBBER NOW!

SUPREME

SUPREME INSTRUMENTS CORP.
GREENWOOD, MISS.
U. S. A.

Export Department:
THE AMERICAN STEEL EXPORT CO., Inc.,
374 Madison Ave., New York 17, N. Y.

MULTIPURPOSE TESTER

(Continued from previous page)

turn selector switch Sw4 to position 6. Run a jumper wire from J1 to J4, and connect the test prods to J8 and J5. Short the test prods together and adjust the shadow angle to 0 degrees. Now connect a resistor to the test prods and adjust the top calibrated dial R16 until the green pattern appears as it did with the prods shorted together. Read the number of degrees indicated and refer to the low range resistance chart.

The high range of the ohmmeter circuit of the tester is operated as follows. Rotate the top calibrated dial to 0 degrees and turn selector switch Sw4 to position 5. Run a jumper wire from J1 to J4, and connect the test prods to J2 and J5. Adjust the uncalibrated dial so that the indicating shadow is 0 degrees with the test prods NOT shorted together. Connect a resistor to the test prods, and adjust the top calibrated dial so that the shadow angle returns to 0 degrees. Read the dial setting and refer to the high range resistance chart.

The low range of the ohmmeter circuit is 400 to 500,000 ohms; the high range is 15,000 ohms to 30 megohms. The two resistance charts can be prepared with the aid of a variable resistance and an accurate ohmmeter.

CONDENSER TESTS

To test paper, mica, or variable condensers connect the jumper wire from J1 to J4; turn the selector switch to position 5; plug in the test leads to J2 and J5, and turn the uncalibrated knob so the shadow angle is maximum (about 100°). Contact the prods to the leads of the condenser. The shadow angle of the indicator tube should momentarily be reduced as the condenser charges. If

the shadow angle returns to normal, the condenser is good; but if it does not return to normal, the condenser is shorted or leaky. If the indicator tube fails to "blink," either the condenser is open-circuited or the capacity is less than about .001 μf . Note that the shadow will not be deflected again until the condenser is discharged or the leads reversed.

Electrolytic condensers are tested in a similar manner with a few exceptions. It is necessary to connect the positive terminal of the condenser to J2 and the negative terminal to J5. When the prods are connected to the condenser, the shadow angle of the indicator tube should be decreased for several minutes. If the condenser is good, the shadow angle will slowly increase until it reaches a constant value. After testing any type of condenser, it should be discharged by short-circuiting the condenser leads. A spark can be noticed with any condenser with a capacity of .01 μf or more.

CAPACITY METER

To measure the capacity of condensers, revolve the top calibrated knob to 0 degrees; turn switch Sw4 to position 6, and connect the test leads to J1 and J4. Adjust the uncalibrated knob so that the shadow angle of the indicator tube is 0 degrees with the prods NOT short-circuited together. Connect (R16) to 0 degrees, and with R15, the condenser to the prods and adjust the top knob in order to deflect the shadow angle back to 0 degrees. Read the number of degrees indicated by the knob and refer to the capacity meter chart.

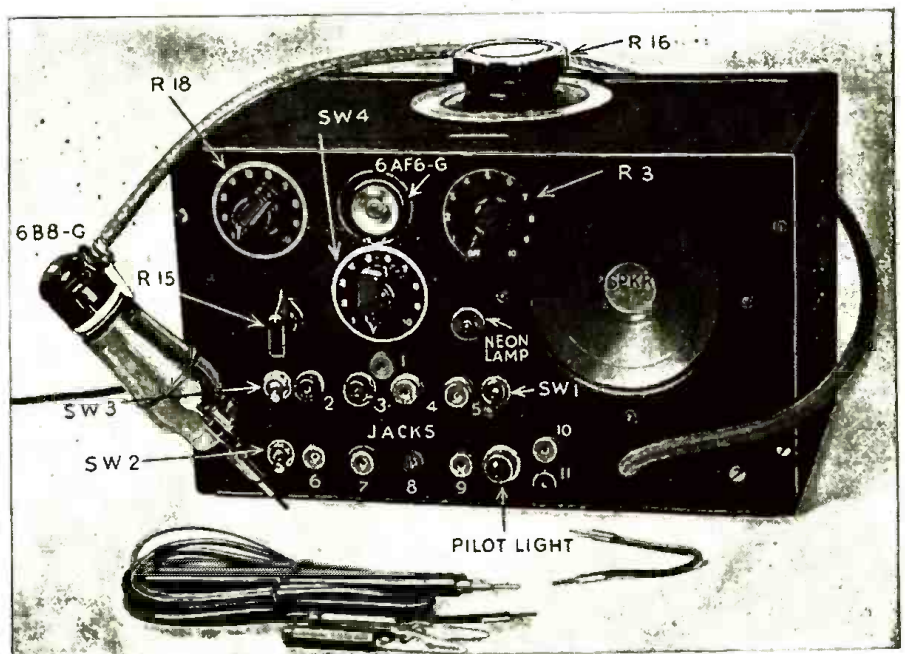

Front view of the instrument, showing controls. Designations refer to the schematic.

If a stock of condensers of known capacity is available, the capacity meter chart can be prepared by recording the number of degrees rotation required for each capacity. The meter has a range of .0004 to .25 microfarads.

The resourceful experimenter will be able to think of many additional uses for this multipurpose tester and signal tracer. The circuit does not employ any expensive precision parts, and makes a very interesting and useful project.

List of Parts

CONDENSERS

- C1, C2—16 mfd. 450 V. electrolytic.
- C3—.005 mfd. 600 V. tubular.
- C4, C17—.05 mfd. 600 V. tubular.
- C5—.02 mfd. 600 V. tubular.
- C6—25 mfd. 25 V. electrolytic.
- C7, C8, C9, C10, C13, C14, C16, C18—.05 mfd. 600 V. tubular.
- C11, C19, C20—10 mfd. 25 V. electrolytic.
- C12, C15—.0001 mfd. mica.

RESISTORS

- R1, R5, R7, R14—500,000 ohm carbon.
- R2—500 ohm 1 W. carbon.
- R3—500,000 ohm volume control with switch.
- R4, R13, R22—100,000 ohm carbon.
- R6, R24—2,000 ohm carbon.
- R8, R21—1 meg. carbon.
- R9—10,000 ohm carbon.
- R10, R12—50,000 ohm carbon.
- R11—250 ohm carbon.
- R15, R18—1 meg. potentiometers.
- R16—750,000 ohm volume control.
- R17—250,000 ohm carbon.
- R19—10 meg. carbon.
- R20—5 meg. carbon.
- R23—10 ohm 10 W. Power.
- R25—50,000 ohm carbon.

TUBES

- 1—5Z4.
- 1—6F6.
- 1—6J7.
- 1—6B8 or 6B8-G.
- 1—6AF6-G.
- 1—6K7.
- 1—6H6.

MISCELLANEOUS PARTS

- 1—Power transformer; primary 120 V. A.C.; secondary 6.3 V. @ 3 A., 5.0 V. @ 2 A., and 350-0-350 V.
- 1—5 inch dynamic speaker with 450 ohm field winding.
- 1—Output transformer with 7000 ohm primary winding.
- 5—"MIP" octal sockets.
- 2—Tuning indicator octal sockets for 6B8-G and 6AF6-G tubes.
- 1—Metal tube shield for 6B8-G tube.
- 3—Grid caps.
- 2—S.P.S.T. Bat-Handle toggle switches.
- 1—S.P.D.T. Bat-Handle toggle switch.
- 1—11 position selector switch.
- 4—Black 1 1/4" streamlined bar knobs.
- 3—Dial plates.
- 1—ICA Precision Vernier Dial (4" diameter, 325°) for R15.
- 7—Red insulated tip jacks.
- 4—Black insulated tip jacks.
- 1—T-2 Tiny Neon Lamp (General Electric).
- 1—Pilot light assembly with 6.3 V. lamp.
- 1—Fuse and fuse mount.
- 1—12" x 7" x 7 1/2" metal cabinet.
- 1—Chassis.
- 1—3 ft. 6 Wire shielded cable for R.F. tube probe.
- Hook-up wire, spaggetti, rubber grommets, and other hardware.

WAR AID TO TELEVISION

Home television will benefit from the wartime development of the television-guided-bomb.

Visual pickups of news events—parades, sports, fires and other occurrences—are made possible by a portable camera-transmitter unit built originally to help bombardiers steer their missiles.

RADIO-CRAFT for MAY, 1946

HARRISON HAS IT!

HARRISON HAS IT!

ALL STANDARD LINES

HSS—HARRISON SELECT SURPLUS



Used in the SCR-299 mobile station (the famous "Voice of Victory") these transmitters are outstanding for their dependable, efficient service. This war-improved version of the HT-4, ruggedly constructed for continuous duty, in modern black console cabinet is suitable for the finest commercial or amateur stations.

Among the outstanding features

Band switching of oscillator and buffer stages—crystal or VFO (Variable Frequency Oscillator) operation—all stages metered—remote Speech Amplifier for control desk—control, and protective relays and interlock switches—modulation limiter—all steel cabinet—33" x 22" x 40" high—link output to transmission cable.

ACCESSORIES

Crystals: Amateur \$4.80, commercial \$19.50
Microphones: with desk stand, cable, and plug \$28.50
Additional sets of coils for commercial frequencies \$40.00

HALLICRAFTERS SIGNAL CORPS TRANSMITTERS!



450 WATT CW
325 WATT PHONE
CONTINUOUS
DUTY OUTPUT

We are having the Hallcrafters factory remove these transmitters from the SCR-299 trucks, and carefully retest and crate them for shipment. A few may have been slightly used for demonstration but all are fully guaranteed to be in perfect condition. We make them available for only a fraction of the original cost! Complete BC-610 transmitter, with BC-614 speech amplifier and connecting cables, all tubes, operating manual, and coil sets for 20, 40, and 80 meter bands (or one set of coils for any other frequency between 2 and 18 Mc.), for 115 Volt. 50/60 cycle \$500

10-METER OPERATION

Hallcrafters is furnishing us conversion kits containing coils, parts and complete instructions for simple changes to permit efficient operation on 28—30 Mc. \$25.00

—RECEIVERS—

LOCAL HAMS!

Come in and get the SCR-299 operating tubes. Heavy plywood, linoleum top, with lamps, cable channel, etc. FB value!
Also select all your requirements from our large stock of all standard lines and many more HSS bargains.

And here are the SCR-299 receivers at a sensational price! One of the finest, most modern communications receivers—sturdy, dependable, compact—excellent for all services. Two RF stages—high sensitivity with exceptionally low noise level—crystal filter—two IF stages—precision dial—4500 division vernier bandspread—ten tubes—0 1/2" x 18" panel with 8" deep metal cabinet—beam power output—phones or speaker—1.5 to 18 Mc. (Use with 2.5 & 10 meter converter for top efficiency on all bands!)

Complete receiver with tubes, speaker in metal cabinet, and instruction manual—ready to operate. Model BC-342, 115 volt 50/60 cycle, \$92.50.
For mobile, marine, etc., or emergency service—Model BC-312, operates on 12 volt battery, \$95.00.

LIMITED QUANTITY!

Wire or Special Delivery your order. Don't wait or they may be all sold. Immediate shipment from New York. 50% with order, balance C.O.D.

A POST CARD will put your name on our mailing list to receive new catalogs, bulletins, additional HSS bargains, and details of how you may obtain, without cost, a copy of "Electronic Parts and Equipment," our new 800-page Buyers' Guide.
PLEASE SEND IT TODAY!

IF YOU WANT to be among the very first to have any new, or not immediately available equipment, get on our "Preferred List."
The factories owe us plenty—and as it comes in we rush it right out!
You can make sure of getting yours quicker by telling us now what you want. (Naturally, orders with deposit come first.) If you change your mind you can cancel without obligation.

HAM HEADQUARTERS
Since 1925!



HARRISON RADIO CORPORATION

12 WEST BROADWAY • NEW YORK CITY 7

BARCLAY 7-9854

JAMAICA BRANCH — 172-31 Hillside Ave. — REPUBLIC 9-4102

Headset Headquarters



Scientifically built Heavy bar magnets greatly increase their efficiency.

Folder R-5 illustrates complete line of Guaranteed

CANNON-BALL HEADSETS

Beautifully designed. Light in weight. Efficient. Reproduce with clarity and good volume. Write

C. F. CANNON COMPANY
SPRINGWATER, N. Y.



Photo Electric Unit

For numerous control applications such as burglar alarms, industrial safety controls, automatic counters and in conjunction with a chime or bell to announce entrance of people in stores and offices. For A.C. Complete with all tubes and SPOT control relay. Net. \$9.45

ADSON RADIO CO.
221 FULTON ST., NEW YORK 7, N. Y.

ANOTHER NEWARK STORE!
AT 212 FULTON ST., NEW YORK 7, N.Y.

Newark ELECTRIC Company

115-117 W. 45th St. NEW YORK 19 323 W. Madison St. CHICAGO 6

Radio Headquarters

for 25 years



We ship at once—parts, equipment, whatever you need!

This house began its career almost as early as Broadcasting itself! Today, 25 years later, we're the world's largest radio supply house! **Standard Lines:** National, Hammarlund, R. C. A., Hallicrafters, Bud, Cardwell, Bliley, and all the others!



SUPERSPEED SERVICE Orders shipped out same day received, on most goods.



ENGINEERING SERVICE If your engineering problem requires special equipment, we'll make it

FREE!

Latest bargain flyer includes test instruments, record changers, communication receivers, ham transmitting tubes and a host of electronic items you need today.



Originators and Marketers of the Famous

Lafayette Radio

Radio Wire Television Inc.

NEW YORK 13 BOSTON 10 NEWARK 2

Cut out coupon, paste on penny post card, mail today

R. W. T. Dept. JES

100 AVENUE OF THE AMERICAS, NEW YORK 13

Gentlemen: Send me FREE copy of your Latest Bargain Flyer C-36, packed with recent electronic equipment and components.

NAME _____

ADDRESS _____

CITY _____ ZONE _____ STATE _____

DEMONSTRATION DEVICES

(Continued from page 533)

ance. When it is adjusted so it will just fire on peaks, the arrow on the rotating wheel becomes visible when vertical with its point up. Since the arrow is rotating clockwise 360 degrees every cycle the *alternating voltage across a coil reaches maximum 90 degrees or one quarter cycle before it reaches maximum across a resistor in series with that coil.*

Lastly turn on and adjust the strobrotion whose grid is controlled by the condenser voltage. It illuminates the rotating arrow when vertical with tip downwards, proving the *alternating voltage across a condenser reaches maximum 90 degrees or one quarter cycle after it reaches maximum across a resistor in series with that condenser.*

Notice that with sine wave variation, current through a coil and hence its magnetic field, is rising fastest at the start of a cycle. Thus the induced voltage which depends on the rate of change of field, must be maximum one quarter of a cycle before the greatest current through, and hence voltage drop across, a resistor. In the case of the condenser the voltage across it will be greatest when it contains the greatest charge. This will be when the total current which has flowed into the condenser reaches maximum, which is just before the current reverses and starts to flow out. This point where the current reverses is one quarter cycle after the maximum current through, and hence voltage drop across, a resistor.

The entire circuit diagram of the stroboscope apparatus is shown in Fig. 1. The 3.5 microfarad condensers came from double 40-watt fluorescent lamp ballasts discarded because of noise or burnt-out coils. The resistor and choke were chosen to give somewhere near the same voltage as is across the condenser, or about 800 ohms and 2 henrys.

DEMONSTRATOR CONSTRUCTION

Turning at last to the discriminator shown in Photo C and Fig. 2, the variable frequency alternating current is supplied from a pair of slip rings connected to diametrically opposite commutator segments on the armature of a two pole, series, direct current motor. Power is supplied from three heavy-duty 45-volt B batteries in series with a carbon pile rheostat to control the speed and thereby the frequency. The end of the motor shaft carries a fly-wheel with an arrow or vector on it which appears stationary when viewed by the light of

a strobrotion fired from a slip ring's a.c. output. A burnt-out power transformer, about 150-watt size, was rewound with two identical windings corresponding to approximately a 220-volt primary except that the secondary winding was center tapped. On the 120 volts at 60 cycles they each drew about one quarter amp. corresponding to something over one henry inductance. Two 5.25- μ f (15-watt fluorescent lamp) condensers in parallel across the primary and secondary coils, tune them to about 40 cycles per second. The "radio frequency choke" is the primary of a small power transformer and its coupling—from center tap of secondary to high end of primary—is made through a 2 microfarad condenser. A 25Z5 supplies the two diodes (reverse line plug or use a transformer if high side of a.c. line affects results through the heater circuit). The 50,000-ohm load resistors have 2-watt neon lamps in series with them for indicators. At radio frequencies the bottom end of the primary of the discriminator transformer is effectively connected to ground through the bypass condenser (.1 μ f is less than an ohm at the frequencies used); and the end of the radio frequency choke going to the center tap of the load resistors is also connected for practical purposes to ground by the bottom resistor's by-pass condenser because a .001 μ f condenser at 4 megacycles offers about 18 ohms reactance. This leads to the important observation that **THE R.F. CHOKE IS EFFECTIVELY CONNECTED ACROSS THE PRIMARY IN SERIES WITH ITS COUPLING CONDENSER.** Because obtaining less than 1 ohm at 40 cycles requires thousands of microfarads, one slip ring was connected directly to the bottom end of the primary as well as to the junction of the two resistors and r.f. choke. These are mounted behind the board and taps brought through to equivalent points on the hookup painted on the front. This does not change operation of the circuit but saves large condensers.

USING THE DEMONSTRATOR

One strobrotion's grid and cathode is connected across the r.f. choke (heavy black in the diagram). A second strobrotion is connected across the upper half of the center tapped discriminator secondary. The remaining strobrotion is connected across the lower half of the secondary. When the motor is started, the slip rings supply a frequency equal

Below Resonance, X_L is less than X_C

Frequency Resonant, X_L Balances X_C

Above Resonance, X_L is more than X_C

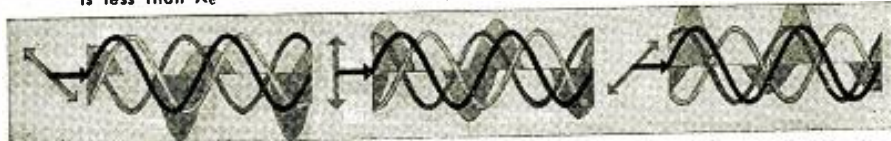

Current leads, output is - Current in-phase, output is 0 Current lags, output is +

Fig. 3—Diagram from bottom of board, showing in-phase, leading and lagging currents.

to its revolutions per second. When this frequency is about 40 cycles the 90-degree leading counter-voltage from the secondary coil just balances the 90-degree lagging counter-voltage from the condenser across the secondary. Remember how the condenser and coil voltages were exactly opposite on the vectorscope? Since there is nothing but the resistance of the circuit offering opposition at this resonant frequency, a considerable circulating or oscillating current is set up, which creates a high counter-voltage across the inductance and an equally high but opposite voltage across the condenser. If the secondary's inductive reactance X_L is Q times its resistance R , this counter-voltage, which equals IX_L , created by the oscillating current through the coil, is Q times the actual voltage induced in the secondary which equals IR . This Q or multiplying factor of the voltage at resonance may be from two to thousands in a radio, so the voltage induced in the secondary can be ignored compared to the back voltage created by the oscillating current in the secondary at resonance.

RESONANT FREQUENCY

The induced voltage from the circulating current at resonance across both halves of the secondary fires the stroboscopes connected to it, producing two images of the arrow 180 degrees apart, and the position of the cardboard carrying the arrow on the flywheel is adjusted until these arrows appear straight up and down and the image of the arrow, made visible by the stroboscope connected across the r.f. choke, is horizontally to the right, half way or 90 degrees between the other two. To secure this last condition the capacity of the $2\mu\text{f}$ coupling condenser may have to be changed. When the voltage across the r.f. choke is half way between the two secondary voltages, the sum of the voltages across the choke and the top

half of the coil equals the sum of the voltages across the choke and the bottom half of the coil. So when these two sum voltages are rectified as shown by the shaded areas, they create equal currents through the top and bottom load resistors as is evidenced by the fact that both neon lamps glow equally. For

this resonant condition, the actual voltage curves and their vector representation together with their rectified sum are shown in the center diagram on the discriminator demonstrator board. See Fig. 3, a reproduction of these curves. Remembering that electron flow is from cathode to plate in a tube, it is easy to see that the equal voltage drops across the two resistors oppose, and hence the total voltage is zero.

RADIO TERM ILLUSTRATED

Suggested by Robert Hopkins, Nelson, B. C., Canada.



Regeneration

for everything in
ELECTRONICS
and **EQUIPMENT**
follow
ARROW!



**RCP Combination
TUBE & SET TESTER**

DC voltmeter 0/10/50/500/
1000 at 1000 ohms per volt.
AC voltmeter 0/10/50/500/
1000.
DC milliammeter 0/1/10/100/
1000 DC ammeter 0/10.
Ohmmeter 0/500/5000/
1,000,000/10,000,000. Low
ohm center.
D.B. meter 8/15/15 to 29/29
to 49/32 to 35 decibels.
Four range output meter—same
as AC volts.
Model 802N complete with self contained batteries. **\$59.50** Net



VOLT-OHM-MILLIAMMETER

One switch for all tests.

DC volts — 0/3.3/7.35/350/
700 at 5,000 ohms per volt.
Milliamps — 0/7/70.
Ohms — 500; 2 megs: 50.
200,000; 5-20,000.
AC volts — 0/7/35/140/700.
Every serviceman needs a rugged meter with 5,000 ohms per volt sensitivity — this unit fills that need. **\$22.50** Net
Price — less leads



**Brentwood
Model K-14
14 WATT P.A. AMPLIFIER**

Especially adaptable for portable use. Provided with 2 input channels, one for microphone and one for phonograph. Duo-stage noiseless mixing between channels. Tone control and pushpull beam power output.

Designed for 110 to 120 volts AC, 50 to 60 cycles. Power consumption: 80 watts.

Tubes used — 1-7C7, 1-7F7, 2-7C5 and 1-5Y4G.

A variety of output impedances available to permit the use of several combinations of speakers. Microphone and phonograph may be mixed at will by using both the microphone and phonograph controls. **\$33.80** Net

Complete with tubes. **\$42.82** Net
with tubes

ARROW
ELECTRONICS COMPANY
82 CORTLANDT ST., NEW YORK 7, N. Y.
Dept. No. 105 Whitehall 3-2696

(Continued on following page)



Superior
RADIO DIAL BELTS

ITS ROUGHNESS ASSURES SMOOTH PERFORMANCE



This Metal Container FREE

Made of buna S rubber (#3 thin single) with smooth rubber cover on outside and rough finish on inside. Standard equipment with set manufacturers — resistant to atmospheric changes — more pliable and rougher — insuring positive grip on shafts and pulleys. Its popularity has made it the largest selling Radio Dial Belt in the U.S.A.

FREE Just pay for the belts and get this metal container

B25A	Service men's Assrt.	25 Belts
B50A	"	50 "
B100A	"	100 "

Use the Belts the Manufacturers use in their original equipment.

Ask your jobber for this handy, durable ALL METAL service-man's sliding drawer cabinet.

J · F · D · MANUFACTURING CO.

4111 FT. HAMILTON PARKWAY · BROOKLYN 19, N. Y.

**Unusual Buy
Cathode Ray Tubes**



& Television Parts

**New Factory Sealed Tubes for
Television and Oscilloscopes**

- DUMONT 7EP4, price\$29.90
 - RCA 5BP4, price 18.00
 - DUMONT 5BP1, price 15.00
 - G.E. Focusing Coil for Electromagnetic Tubes, price 9.50
 - RCA Television switch with 5 Antennae RF transformers, price ... 5.60
 - G.E. CR Power transformer 1700 V., 6.3 V., 2.5 V., price 9.90
 - Cathode Ray tube socket with H. Voltage wiring, 11 Pole Magnal, price 2.40
 - 14 Pole Di-Heptal, price 2.40
 - Cornell-Dubilier Oil Filter tubular Capacitor .1 mfd 3500 V., price 1.80
 - .02 mfd 2500 V. Sprague tubular Capacitor, price90
- All types ceramic, mica and oil capacitors, trimmers, coaxial cable, etc.

Send 50c for complete catalog including diagrams for RCA, G.E., DUMONT and ANDREA Television Receivers, free with order \$5.00 and more.

RCA Parts and Equipment Distributors
World's First Specialized House
In Television

ELECTRONICS SERVICE, & SUPPLY
Dept. RC, 268 W. 40th Street,
New York 18, N. Y.

DEMONSTRATION DEVICES

(Continued from previous page)

agram at the bottom of the discriminator demonstrator board and its reproduction in Fig. 3.

As the motor speed slows and the frequency falls one can watch the two secondary vectors shifting counterclockwise, indicating a lead because the clockwise rotating arrow is illuminated before it reaches its former visible position. (Convention imagines vectors to rotate counterclockwise so a counterclockwise shift means they have advanced from their former position relative to the primary voltage across the black r.f. choke.) At the same time it is obvious the sum of the "black" and top voltages is now less than the black and bottom as is proved by the top neon lamp going out and the bottom one's plate becoming fully covered by glow. Thus the total voltage across the two resistors no longer balances out to zero, but is negative to ground since the electrons piling up at the top end of the bottom resistor make that end negative and their shortage at the grounded end of the same resistor leaves it positive.

ABOVE RESONANT FREQUENCY

Lastly increase the input frequency by speeding up the motor. The condenser now charges oftener per second

so there is more current into it and its reactance X_C must be less. The secondary's field, reversing oftener per second, induces more voltage, so its reactance X_L increases. When inductive reactance X_L exceeds capacitive reactance X_C the greatest reactionary voltage occurs early in the cycle (remember how the back voltage across the coil was ahead of that across a resistor or condenser?) and the maximum current does not flow until later, or in other words the current lags.

As the whirl of the motor gradually increases in pitch the two vertical secondary vectors slowly turn clockwise from their 90-degree position relative to the black primary vector which remains unchanged and the upper load resistor lamp glows brighter while the bottom load resistor lamp dims, indicating that the sum of the choke and top coil now exceeds the sum of the choke and bottom one. This makes the top end of the two resistors positive to ground since the electrons accumulate at the lower entrance to the top resistor making that end negative while their scarcity at the top of this resistor makes it positive.

MECHANICAL ANALOGY

The conditions just observed, namely: at low frequency the condenser offering the chief opposition at the end of the cycle (so the current led) and at high frequency the inductance offering the chief opposition at the beginning of the cycle (so the current lagged) have a mechanical counterpart, lucidly described by Drysdale, "If a steel bar with a weight on the end of it is clamped in a vise, and is pulled to one side and let go, it will vibrate to and fro with a definite frequency. If we take hold of the end of it and move it backwards and forwards very slowly, we shall feel that elastic force of the spring, which is greatest at the end of the stroke, practically as if there were no weight. But now start to move it more rapidly, and it will be found that it swings much more easily; or if the same force is exercised the swing will be much greater, until when we move it with the same frequency as that with which it vibrated itself, it will move almost without any force from the hand at all, and if we were to continue to exert the same force as at first, the swing would become so great as perhaps to break the spring (just as a condenser).

"But if we try to move it much more quickly still, we shall now find a greater resistance to the motion owing to the inertia of the mass, and we shall also find that our greatest force in a given direction has to be exerted at the beginning of the stroke in that direction, whereas it had to be exerted at the end when we were moving slowly and the inertia effect was small in comparison with the elastic force of the spring. In other words the force has changed from lagging to leading after passing the natural vibration frequency, just as with the electrical circuit containing capacity and inductance."

The amount of voltage produced at the discriminator output depends on the extent of the frequency swing or deviation and governs the intensity of the sound in radio or contrast of the picture in television. The frequency of the voltage changes in the discriminator output depends on the number of frequency swings or variations per second and governs the pitch of the sound or fineness of picture detail.

This apparatus is a very definite help in teaching alternating current theory.

Since the foregoing was written it became evident that the transformer primary should not be connected to the slip rings until the motor comes up to speed. On one occasion the motor happened to stop with the two commutator segments, which are connected to the collector rings, directly under the brushes. When the demonstrator was started the next time there was a severe flash which badly burned these two segments, because the d.c. went directly from the brushes through the low resistance transformer primary, and as the armature turned the commutator segments interrupted this heavy flow and the arc from self-inductance badly burned the bars. To prevent a recurrence of this a switch opens the line from the rings to the transformer primary until the generated a.c. frequency approaches the resonant frequency of the tuned primary.

VISUAL RADIO ALIGNMENT

(Continued from page 540)

the output frequency of OSC. No. 2, the external unmodulated r.f. oscillator, to 635 kc we would obtain the desired signal as follows:

OSC. No. 2	635 kc	635 kc	635 kc
OSC. No. 1	450 kc	460 kc	470 kc
Output Difference Freq.	185 kc	175 kc	165 kc

If the i.f. frequency were 262 kc OSC. No. 2 would be set at 622 kc:			
OSC. No. 2	622 kc	622 kc	622 kc
OSC. No. 1	450 kc	460 kc	470 kc
Output Difference Freq.	172 kc	162 kc	152 kc

Note that in both cases, although the mean frequency is different for the output frequency, the band width remains the same. Of course, if the i.f. of the

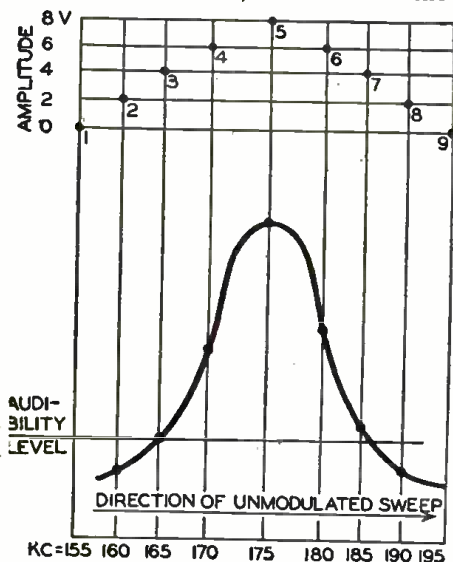

Fig. 3—Output curve, constant signal input.



Fishing for your radio equipment is a gamble—you don't know what you'll get or when you'll get it.

Let Sun Radio do your fishing for you. We have lines thrown out to every leading manufacturer, and each hook is baited with our highly-regarded reputation which enables us to get prime consideration.

The result is our half million feet of well-stocked shelves. No matter what you want, one call to Sun will probably get it — the FIRST time.

Call SUN First

Note our ONE and ONLY address

SUN RADIO & ELECTRONICS CO., INC.
122-124 DUANE ST.
NEW YORK 7, N. Y.
BARclay 7-1840

FREE OFFER

Condensed chart of Graphical Symbols for Electronic Diagrams as standardized by the RMA (includes those until recently kept secret). Just ask for it. Address Dept. GR 5

receiver lies in the range covered by the FM signal generator (415 to 540 kc) as is the case with the majority of receivers, it is not necessary to use the external signal generator because the wobulator's signal is satisfactory in itself.

To discuss some of the units used to align FM receivers here would be unnecessary, as their only essential difference from the unit in Fig. 2 is that they operate at higher mean frequencies and band widths in the neighborhood of 300 to 400 kc.

Amplitude of the frequency-modulated signal must remain constant throughout the entire frequency swing. The necessity for this will be seen in Fig. 3, which illustrates the shape of a typical resonance curve for a single- or double-tuned i.f. transformer which is peaked at 175 kc and has a band width of 10 kc. This curve tells us that the i.f. transformer for which it was drawn is designed to pass a signal frequency of 175 kc with minimum attenuation. Further, as the frequency is increased or decreased, the amplitude response drops off sharply until it falls below the level of audibility for all frequencies below 170 kc and above 180 kc. Therefore, the transformer, or strictly speaking, the resonant circuit, is said to reject or suppress all frequencies except those lying within the range from 170 to 180 kc. Note that the cali-

(Continued on following page)

HEAVY POWER
225 WATTS

LIGHT WEIGHT
14 OUNCES

made possible by
KWIKHEAT'S
BUILT-IN
THERMOSTAT

- * HEATS IN ONLY 90 SECONDS
- * MAINTAINS PROPER HEAT
- * LESS RETINNING NEEDED
- * COOL, SAFE HANDLE
- * TIPS LAST LONGER
- * CAN'T OVERHEAT
- * LIGHT WEIGHT
- * 6 TIP STYLES INTERCHANGEABLE

The Kwikheat Iron is powerful — 225 watts. A built-in thermostat maintains ideal temperature — far best soldering, prevents overheating, prolongs life of tips, saves retinning time. Kwikheat is hot, ready to use only 90 seconds after plugging in. Light (14 ounces); well-balanced, cool handle. Complete with #1 tip. \$11.00

*patented
VANATTA
kwikheat
THERMOSTATIC SOLDERING IRON
A DIVISION OF
SOUND EQUIPMENT CORP. OF CALIF., GLENDALE 4, CALIF.

G-E TUBE CHECKER

Quick, easy, accurate tube checking which saves you time and trouble and keeps your customers happy—that's the job the TC-3P is built to do. Line Voltage and tube quality, or shorts, may all be checked on one selector switch. Individually operated switches permit placing the proper voltage on the proper pin of the tube. The G-E Tube Checker is available in either the Portable (TC-3P) or Counter Model (TC-3). Write: Specialty Division, Electronics Department, General Electric Company, Syracuse, New York.

GENERAL ELECTRIC

177-01

Electronic Measuring
Instruments



TC-3P

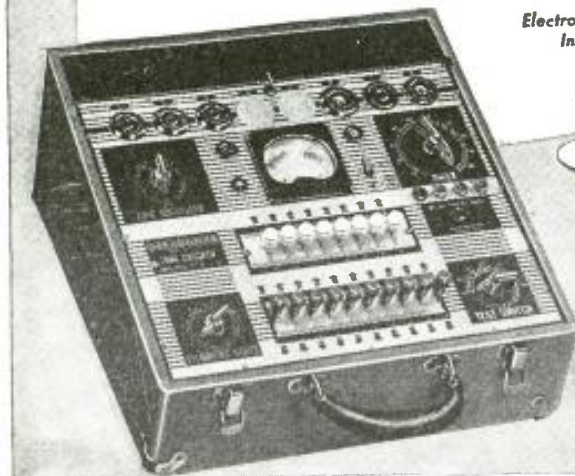

view the curve instantaneously in the form of a trace on the screen of the instrument. But to do this, the sweep frequency of the oscilloscope must be twice the rate at which the output of the signal generator sweeps across the band width and back again (from 170 to 180 kc and back to 170 kc). The reason is that the trace representing the i.f. response curve will not stand still on the screen unless this requirement is fulfilled.

The sweep frequency circuit of the oscilloscope is a low-frequency oscillator usually combined with suitable amplifiers to produce the bright horizontal line across the scope face. The sweep-



Fig. 4—The single-curve alignment pattern.

producing circuit is a *sawtooth oscillator*, producing a special type of curve. The voltage rises slowly, causing the spot of light to move across the oscilloscope screen, tracing out a line. On reaching its peak, the voltage falls suddenly to zero, causing the spot to fall back to the left side of the screen instantaneously. Since the sweep frequency is set to twice that of the "wobulator," the spot sweeps once across the screen as the signal generator is being swept from 165 to 185 kc, and a second time as it is being swept from 185 to 165 kc. In reality there are two curves instead of one, but the second curve is not visible because it is exactly on top of the first one. The reason for this will become apparent when it is noted that the response curve has the same shape whether you go from 165 to 185 kc or from 185 to 165 kc. Therefore, when the frequency of the FM signal reaches 185 kc the sawtooth voltage drops to zero, returning the trace to the left-hand side of the screen, and as the sawtooth voltage rises again, the frequency from the signal generator sweeps from 185 to 165 kc. As the response going from 185 to 165 kc varies exactly as it does in going from 165 to 185 kc, the second curve falls di-

Service Supervisor Wanted by Electronic Organ Manufacturer

Unusual opportunity now open for the right man. Must be under 40 years of age and of sound health; have personality which will enable him to meet people of average culture or better, make friends with them quickly, and influence their thinking; sales or other business experience definitely valuable but not absolutely necessary if other qualifications are tops. Position will entail some traveling.

Must be thoroughly familiar with audio circuits and components. Must have proven ability in writing effective service notes and installation instructions. Must be able to set up, train and supervise field force.

Position with old established but progressive firm with highest financial rating. Write immediately giving full particulars and complete history of activities for past ten years, in first letter. Box My-6, c/o RADIO-CRAFT, 25 West Broadway, New York, N. Y.

VISUAL RADIO ALIGNMENT

(Continued from previous page)

brations extend from 165 to 185 kc to provide a base for the curve. The same must be done with the frequency modulated signal to obtain a base for the trace on the screen of the oscilloscope.

The response curve in Fig 3 could have been obtained by connecting a meter across the diode load resistor, recording the drop across it for a number of frequencies introduced by an ordinary signal generator, and then plotting the curve from the data. It is apparent that the amplitude of the input signal must be kept constant or results will be meaningless.

Because the cathode-ray oscilloscope serves as a voltmeter, it is possible to

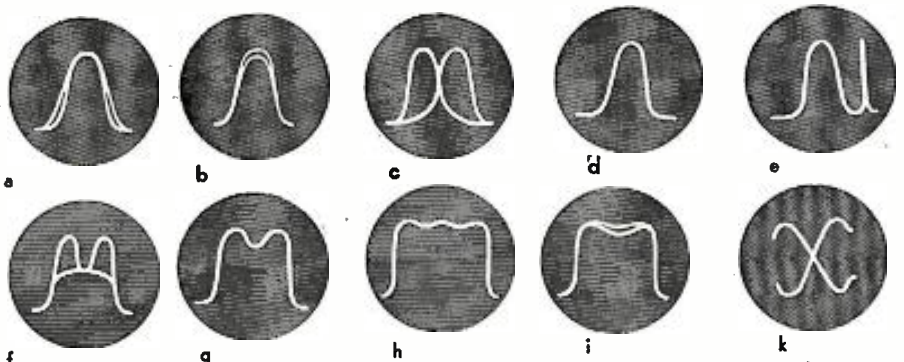

Fig. 5—These patterns indicate a variety of conditions, which are explained in the text.

rectly on top of the first, giving the appearance of a single curve.

In addition to double curves, single curves are also used. This is accomplished by keeping the sawtooth voltage at zero during the period when the frequency of the generator passes from 185 to 165 kc. The resultant curve is shown at Fig. 4. The sharply rising line to the right of the curve is the second curve, but it is collapsed into a line due to the absence of the sawtooth deflecting voltage.



Fig. 6—Alignment pattern for a.f.c. circuit.

The method of connecting the signal generator and the oscilloscope varies with the type of circuit to be aligned. In a receiver which uses a diode detector, the vertical plates of the oscilloscope should be connected across the diode load resistor. When the receiver employs a triode biased detector, a satisfactory procedure is to open the bias resistor and by-pass condenser circuit, and then to connect the vertical plates of the oscilloscope from the cathode to ground across a 0.5 megohm resistor which has been by-passed with a 250 μ f condenser. It is also advisable to short out the plate load; although this will invert the trace it does not affect the alignment procedure.

The FM signal generator is connected to the input of each particular stage, just as any other signal generator would be. The order of procedure for visual alignment is identical to that which is followed when an output meter is employed. Alignment starts at the back of the receiver and works toward the front, feeding the signal into the last i.f. amplifier input, the next-to-last, and so on, until the converter is reached. The object is to adjust the trimmers of the stage into which the signal is being fed until a symmetrical curve is obtained. This applies equally as well to both the single and double curve methods. Fig. 5 shows some scope patterns commonly used.

The curves at a, b and c of Fig. 5 indicate various conditions of misalignment. The curve at d indicates correct alignment. Adjustment of the trimmers will not always result in a symmetrical resonance curve. Slight departures from exact symmetry are permissible, however, if the departure is great, such as it would be when the degree of coupling is excessive and regeneration is present, the circuit itself should be suspected and examined. Thus, visual alignment serves as a check on potential trouble in the customer's home, which would ordinarily leave the shop undetected.

Fig. 5-e is the same curve as that in 5-d except that the single trace method

Sweet Savings ON 600-V. CONDENSERS

Here's a great OLSON bargain: 70 By-Pass Condensers, made to rigid Olson specifications. Will withstand voltages higher than ratings. Worth much more than our low price. Order now!

\$4.95
POSTPAID

Small size (approx. 1 1/2" long, 1/2" dia.) makes these units right for compact circuits. Long tinned copper leads. You get SEVENTY 600-V. Tubulars, as follows:

QUANTITY	CAPACITY	QUANTITY	CAPACITY
20	.01	20	.05
10	.02	20	.1

This offer good only in U. S. A.



FREE Panel Lamp Tool

with each Condenser Kit ordered. Rubber tool grips bulb for easy installation or removal in hard-to-get-at positions. Mighty handy!

Send for our free Bargain Catalogs

MAIL TODAY **OLSON** RADIO WAREHOUSE

Stock #TC-A

73 E. Mill St., Dept. 23, Akron, Ohio

Send me _____ Kits of 70 Condensers each, at \$4.95 per Kit postpaid. I enclose \$_____ I will receive a Panel Lamp Tool FREE with each Kit ordered.

NAME

ADDRESS

Learn

RAPID RADIO SERVICING

approved for
Veteran Training

Our specialized training develops radio repairmen who have 200 hours actual servicing experience when they leave school. Course trains for AM, FM, Television, Broadcast and Amateur. This is no ordinary course. For particulars write:

IVAN D. LONG, President
Western Radio Institute
1457 Glenarm, Denver 2, Colo.

was employed. Figs. 5-f and 5-g illustrate misalignment and alignment for a typical triple-tuned i.f. transformer such as might be encountered in a high-fidelity receiver. Fig. 5-h illustrates correct alignment for a transformer of sim-
(Continued on following page)

RADOLEK

Radio-Electronic Service Parts

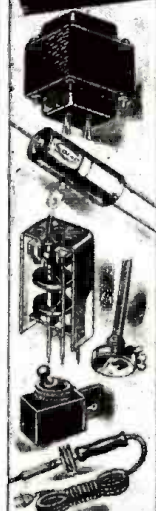

Large stocks assure the finest and most complete selections of all available items at lowest prevailing prices. Thousands of active buyers depend on us for their entire Radio repair and replacement requirements. Because we understand service problems, every order is expedited for delivery in double quick time. Everything we do is planned for convenience and satisfaction to our customers. You will find it profitable to make Radolek your buying headquarters.

FREE BUYING GUIDES

Because of existing conditions we keep our customers right up to the minute on available merchandise by releasing supplements frequently instead of sending our regular Big Profit Guide once a year. Send the coupon now to get these Free Buying Guide Supplements as they are issued.



FAST SERVICE!

RADOLEK CO., Dept. C-114
601 W. Randolph St., Chicago 6, Ill.

Please send FREE Buying Guide Supplements

NAME _____
ADDRESS _____

ORDER FROM RADOLEK

HAM HEADQUARTERS FOR

Equipment and Information

EXTRA SPECIALS

- Leach Relay
Low Loss D.P.D.T.
6V. D.C. Coil
\$1.75 Net
- 3C/24 G. Tubes
Limited Supply
\$1.90 Net
- 10 M.C. I.F. Trans.
Doubled Air Tuned
90c Net
- 8 x 8 M.F.D.—600 V.
Oil Impregnated
4 prong base
\$2.10 Net

Mail Orders Promptly Filled
Amateurs to Serve You

Write Dept. RC
W6SCQ—W8WLG/6—W6NAT
W6SSU

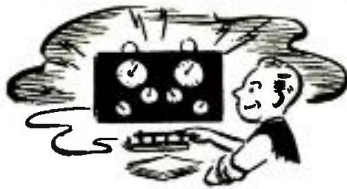

FOR YOUR NEW RIG

- Monitor Crystals
Type 43B, 7 Mc. \$2.83 Net
Type 43C, 14 Mc. \$3.75 Net
Type 43D, 28 Mc. \$5.50

Also complete Line of:
NATIONAL EIMAC
JOHNSON JONES
OHMITE AMPREX
TAYLOR ADVANCE
BARKER-WILLIAMSON
HALLICRAFTERS

Radio Product Sales Company

238 WEST 15TH STREET
LOS ANGELES 15, CALIFORNIA PRespect 7471

SOUND VALUES at TERMINAL RADIO

IN STOCK!

MEISSNER 6 Tube AC-DC Radio Kit

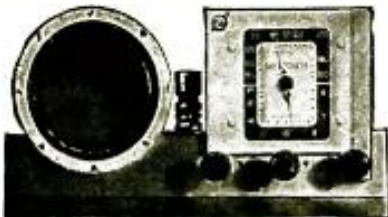

Frequency range covers the broadcast band from 550 to 1600 Kc and the short wave band from 6 to 18 Mc. Three controls provided: Tuning, Band Switch and Volume. On-off switch incorporated in volume control.

Complete with all parts, hardware, wire, solder, speaker, tubes, pictorial and schematic diagrams.

\$24³⁸

NET. F.O.B. N.Y.
Cabinet for above (walnut wood) Net \$3.75

Shipping weight, less cabinet 10 lbs.

TERMINAL

Radio Corporation

85 CORTLANDT ST. N. Y. 7, N. Y.
WOrth 2-4415

VISUAL RADIO ALIGNMENT

(Continued from previous page)

ilar design; the single-curve method was used. Note that there are two peaks in the curve at 5-g, and three in the curve at 5-h. The possibility of aligning a high-fidelity set as accurately as this with an output meter is extremely remote—the result is a loss in fidelity.

The same principles of alignment are applicable to FM receivers. Of course, the frequency range and the band width of the signal generator must be high enough to cover the FM band, as pointed out previously. The i.f. stages may be aligned by connecting the discriminator as a diode detector, so that the drop across the load will provide the vertical deflection voltage for the oscilloscope. Fig. 5-i shows the pattern which indicates correct alignment. After this the discriminator transformer is aligned so as to obtain a trace such as that shown at Fig. 5-k. This curve is obtained by first adjusting the primary until the linear portions of the curves are greatest; a secondary check is that peaks will have their maximum amplitude when correct alignment is obtained. The secondary is then adjusted until the intersection of the two curves lies halfway between the peaks.

Some higher-priced sets incorporate a.f.c., which must be checked for correct alignment. A representative trace which illustrates correct alignment is

shown in Fig. 6. Many manufacturers provide detailed directions for visual alignment of their particular receivers which may differ from the very general directions given in this article because of circuit considerations. It is advisable to consult the available technical data on each particular set which is to be aligned to determine if such is the case.

LOGIC—A REPAIR TOOL

(Continued from page 543)

ments being normal, he will turn his attention to the capacitors in the set. This will often involve freeing one end of the condenser from the circuit and checking for the slow swing of the ohmmeter needle.

The direct measurements technique has much to recommend it. Since most circuit disorders result in a change of operating voltages, the troublesome component can often be located rapidly. Not all troubles however, manifest themselves as voltage abnormalities, and in these cases the direct measurements approach becomes a long and tedious process.

CHANNEL SUBSTITUTION

To the advocate of this servicing procedure, a radio receiver is the sum total of its individual sections, each serving its own individual purpose and adding its result to the total performance of the receiver. To him, the receiver is divided almost anatomically. It is a collection of separately functioning sections, operating interdependently, and blending their services to the ultimate result. It follows that a failure in any one section will detract from the total operation of the receiver, and the serviceman deals with sections.

This type of serviceman is not interested primarily in circuits, voltages, or signal transfer; he prefers to work with block diagrams. He is interested in purpose rather than means of accomplishment. He is a student of functional analysis. He does not see the receiver as a conglomeration of resistors, capacitors, inductances, and tubes; he sees it in terms of sections: r.f. amplifiers, oscillators, i.f. amplifiers, detectors, and a.f. amplifiers.

He must of necessity have a working knowledge of basic and conventional circuit design, but the mental picture ac-

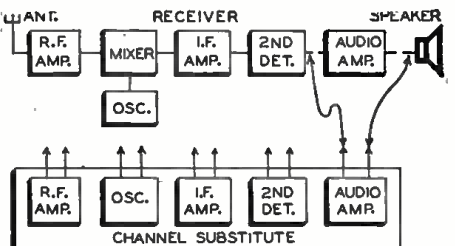

Fig. 4—Set-up for channel substitution test.

companying his servicing is a block diagram as shown in Fig. 3.

His first task is to locate the faulty section. To this end he may arrive by several means, but the true type of

"section" serviceman will use a channel substitute. The channel substitute is an instrument containing and duplicating the different sections of a receiver. It contains r.f., i.f. and a.f. amplifiers as well as detectors and oscillators.

In practice, this serviceman will check each section of the receiver in question, by substituting for it the functional equivalent in the channel substitute instrument. For instance, if he suspects the audio amplifier of the receiver, he will take leads from the audio amplifier in the channel substitute and connect them between the second detector and

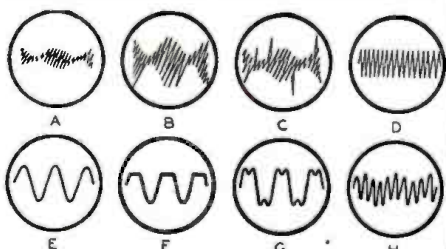

Fig. 5—How troubles show up on C-R 'scope.

the loud-speaker of the receiver. If the receiver then resumes normal operation, his suspicions are confirmed and he knows that the trouble lies in the a.f. section of the receiver. This channel substitute test is illustrated in Fig. 4.

If the audio amplifier is operating normally, he goes on to check other sections of the receiver. Next, he will substitute the second detector of the channel substitute for the receiver's second detector. In this way he will substitute each section of the channel substitute for its corresponding section in the receiver, until the faulty section is discovered.

Intense effort is then concentrated on this faulty section to locate its single malfunctioning component. This will involve the use of such test equipment as tube checkers, volt-ohm-milliammeters, capacitor testers, etc. Thus the channel substitute method of servicing is a pure type only up to a certain point, after which some other method of approach must be employed.

Several well known shortcuts have become popular supplements to channel substitute testing. For instance, the audio amplifier may be checked by shorting the heater and cathode at the base of the first audio tube to see if the 60-cycle note is transmitted through the audio section to the speaker.

A quick check for r.f. sections employing grid-cap types of tubes is to touch the antenna lead-in wire to each of these grid caps in turn, to determine which stage of r.f. is inoperative.

Intermediate frequency amplifiers can be checked by probing around with a lead from a crystal detector in series with a pair of headphones. (Continued on following page)

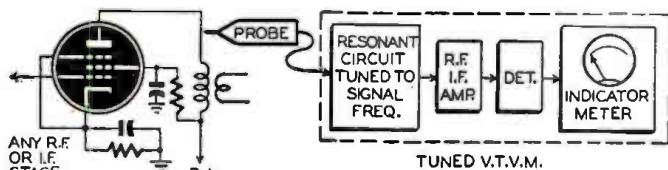

Fig. 6—Block diagram of tuned channel analyzer or signal tracer.

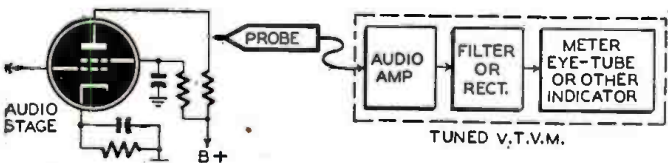

Fig. 7—For audio circuits, much simpler apparatus may be used.

HOW TO PASS Commercial Radio Operators' FCC LICENSE EXAMINATIONS...

How To Pass
FCC
LICENSE
EXAMINATIONS

CLEVELAND INSTITUTE
of
RADIO ELECTRONICS
Terminal Tower - Cleveland, Ohio

FREE BOOKLET

Tells you the Government Requirements for all classes of commercial licenses. Saves you many hours of random, undirected study. Assures a minimum of time in getting your ticket!

CLEVELAND INSTITUTE OF RADIO ELECTRONICS

Successors to Nilson Radio School, founded 1939;
Smith Practical Radio Institute, founded 1934

RC-5 TERMINAL TOWER

CLEVELAND 13, OHIO

MAIL THIS COUPON

CLEVELAND INSTITUTE OF RADIO ELECTRONICS
RC-5 Terminal Tower, Cleveland 13, Ohio

Gentlemen: Please send your FREE Booklet, "How to Pass FCC License Examinations."

Name

Address

City Zone State

Electricity

FOR RADIO AND
ELECTRONIC APPLICATIONS

ONAN ELECTRIC GENERATING PLANTS supply reliable, economical electrical service for electronics and television applications as well as for scores of general uses. Driven by Onan-built, 4-cycle gasoline engines, these power units are of single-unit, compact design and sturdy construction. Suitable for mobile, stationary or emergency service.

Model shown is from W2C series; 2000 to 3500 watts; powered by Onan-built, two-cylinder, water-cooled engine.

D. W. ONAN
AND SONS
5428 Royalston Avenue
Minneapolis 5 Minn.

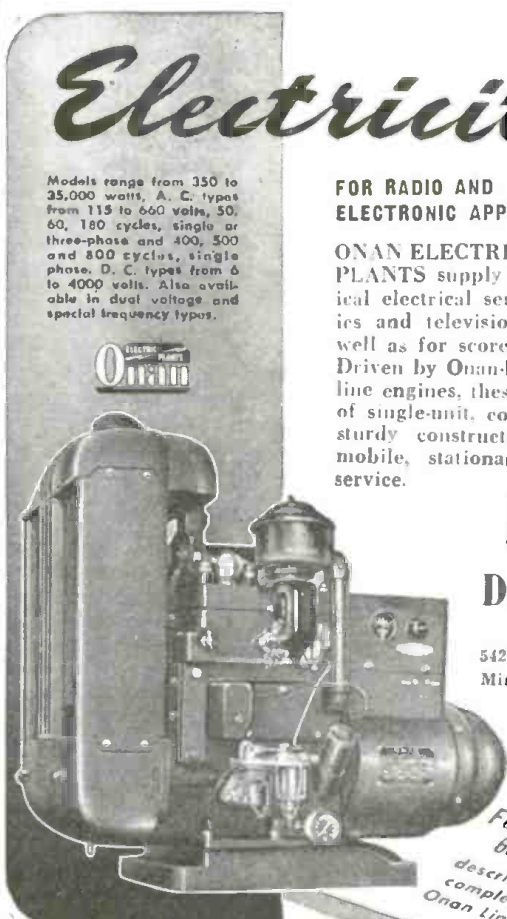

Write
For Folder
630-A
describing
complete
Onan Line



Civilian RADIO JOBS Wanted

FREE WANT-AD SERVICE

By FORMER SOLDIERS, SAILORS, MARINES

Radio-Craft offers its help-wanted columns free for the use of honorably discharged men in the armed services. State the type of position you seek, preferred locality, your experience, education, and other details. Confine ad to 50 words, or less. Supply name and address. Army veterans send section number or photostat of discharge paper. Navy men send photostat of discharge paper. Address RADIO-CRAFT, Classified Ad, Dept. 25, West Broadway, New York 7, N. Y. Your ad will contain a box number and replies will be forwarded to you.

AVAILABLE

RADIO TECH.: 20, 1st cl. phone; transmitters; 9 yrs. exp., married. S. P. Brook, Box Y-1. % Radio-Craft, 25 W. B'way, New York 7, N. Y.

RADIO TECH.: 2/c Rad. Telephone, Telegraph Licenses. Army and Civ. exp. Will accept short training program. Ted Schwartz, Box Y-2. % Radio-Craft, 25 W. Broadway New York 7, N. Y.

RADIO-Radar: 2 yrs. radar exp. In Army. C. Rubenstein, 1530 St. Nicholas Ave., New York 33, N. Y.

RADIO Technician and Operator. 1st class Telephone License, 3 yrs. Army experience. C. Quint, 391 Riverdale Ave., Brooklyn 12, N. Y.

RADAR-RADIO TECH.: Exp. in F.M., Broadcast-ing, F.C.C. Lic. Seek any Electronic Field. N. Miller, 1494 Crotona Park East, Bronx 60, N. Y.

COMM. TECH.: 3 1/2 yrs. exp. A.M., F.M., V.H.F. Instructed Mechanics 2 1/2 years. Desire interesting work. L. Solomon, 3127 Coney Island Avenue, Brooklyn 24.

RADIO OPPORTUNITY: Have 6 yrs. top radio exp. FCC License, and large finished room available. Desire ideas, assistance for production basis. M. Koffer, 743 Hendrix Street, B'klyn 7, N. Y.

YOUNG MAN mechanically inclined, interested in Radio. Seeks position with future. 3 years A.A.F. experience. Sidney Davidson, 1109 E. New York Ave., B'klyn 12, N. Y.—FH 2-0818.

RADIO TECH.: Oper. Maint. Comm'l. H'least. G.I. Radio exp., FCC Lic's. Murray Brown, 149 So. 4th Street, B'klyn, N. Y. EV 7-5897.

RADIO-RADAR TECH.: 1/c Illinois license, 3 yrs. army electronics. M. Berent, 1710 W. 4th St., Brooklyn 23, FS 6-0903.

RADIO: 4 yrs. civilian exp.; 3 yrs. army, 3 yrs. maint. school. A. Blindler, 461 Barbey St., Brooklyn 7.

RADIO TECH.: 6 yrs. exp., ex-Naval radar. V.H.F., will work firm. S. Rosenstein, 1826 Bathgate Ave., Bronx 57.

RADIO-RADAR TECH.: 4 yrs. exp. mainte., repair; knowledge communication equip. H. Nathanson, 2872 Bright, 4th St., Brooklyn 24.

ELECTRONICS, exp. tech., civilian exp., desires work in field. D. Loran, 393 Ocean Ave., % Slonim, Brooklyn 26, BU 4-2815.

RADIO TECH.: civilian exp.; 2 yrs. army, 3 yrs. willing worker. A. Hausmann, 1447 Longfellow Ave., Bronx 59, DA 9-0332.

RADIO TECH.: exp'd tester, trouble-shooter, lab-assst.; 3 yrs. Eng. college. S. Geller, 1879 Prospect Ave., Bronx 87.

RADIO WORK desired; limited exp.; hold operator's license, school nights. M. Petroff, 140 Baruch Pl., N. Y. 2.

RADIO RADAR: 3 1/2 yrs. exp.; AAF Instr.; draftsman. H. Rosenblum, 205 Sea Breeze Ave., B'klyn 24, ES 2-6904.

RADIO JOB—2 yrs. Army radar exp.; wages secondary; 23. M. Yochel, 2773 E. 15th St., Brooklyn 29.

RADIO TECH.: 3 1/2 yrs. exp. repair, maint., radio, radar equip., signal corps. A. D. Arlin, 291 Montauk Ave., Brooklyn 8, AP 7-1527.

RADIO Wireman; 3 yrs. exp., 9 yrs. exp. electrolytic condensers. J. Hanish, 1966 62d St., Brooklyn 4, RE 6-8156.

ELECTRONICS: Navy; civilian; exp. audit; LEF technique; radio-radar circuits; 20. D. Schalterman, 775 So. Blvd., Bronx 35.

RADIO Repairman; 3 yrs. army training; exp'd; 23. married. G. Spiro, 652 So. Blvd., N. Y. 35.

RADIO TECH.: 2 yrs. army exp. start as trainee lab. asst. M. Kramer, 1256 Brook Ave., Bronx 56.

RADAR TECH.: 3 1/2 yrs. exp. excel. electronic trans. latest airborne equip't. I. Gerstein, 612 Argyle Rd., Brooklyn 30.

ELECTRONICS; knowledge radio and electrical theory and elec. drafting; 22; H.S. grad. R. Sergio, 500 W. 213th St., N. Y. 34, LO 7-9817.

RADIO TECH.: 3 yrs. coll. in radio eng'g. Dia. experimental work. D. Jacobs, 107 Hart St., Brooklyn 6; EV 8-4819.

RADIO TECH.: 3 yrs. exp. seek job in lab.; willing to work. H. Reiner, 47 Bay 26th St., Brooklyn 14.

RADIO, Telegrapher Oper.: 2 1/2 yrs. army exp. A. Diamond, 653 Marcy Ave., Brooklyn 6.

RADIO TECH.: married; 2 1/2 yrs. exp.; AM, FM receivers, transmitters; apprenticeship accepted. A. Lensky, 125 Ten Eyck Walk, Brooklyn 6.

RADIO TECH.: 22; 3 yrs. exp. AAF; attend coll. nights. R. Kreisler, 738 Saratoga Ave., Brooklyn 12.

RADIO OPERATOR AND TECH. Interested in a job in the radio field. Have been a radio operator in the Army for three years. Also have a license.

Bernard Mishkin, 351 Hinsdale St., Brooklyn, N. Y. DJG-1950.

RADIO, RADAR—4 1/2 yrs. experience. Interested in recording, television or radio. Salary secondary. Willing to study evenings. Bernard Resnik, 2006 Benson Ave., Brooklyn, N. Y.

EX-NAVY RADAR TECHNICIAN. 3 years' experience in operation, maintenance and repair. Seek position with a future in Radio, Radar or Television. At present I am attending R.C.A. Inst. evenings. Salary is secondary. J. J. Korngold, 154 Kings 1st Walk, Brooklyn, N. Y.

RADIO, RESEARCH LAB. ASSIST. Experience radio repair. Tech. school grad. Electrical mech. L. Polasky, 612 Ocean Ave., Brooklyn 26, N. Y.

RADIO TECH., coll. grad., exp. Army maint. repair, recs. trans. M. Josephberg, 491 Willoughby Ave., Brooklyn 6; EV 7-3076.

RADIO TECH.: 24; exp. 3 1/2 yrs.; army; salary secondary, job with opportunity. Ben Greenberg, 2725 Barker Ave., Bronx 67.

RADIO, 3 1/2 yrs. exp. Navy radio tech. adaptable to any position. P. Guzzo, 163 Hamrod St., B'klyn 21.

RADIO COMMUNICATIONS: pos. with future, amateur license, knowledge tyding. David H. Bierman, 2063 Mapes Ave., Bronx 60.

RADIO TECHNICIAN: exp. receiver, transmitter; interested in any phase of radio, electronics. Marcus Wittenberg, 805 St. Marks Ave., B'klyn 13.

RADIO, electronics, 3 yrs. exp. Army, civilian schooling testing P. A. M. Shack, 1855 E. 13th St., B'klyn 20; ES 5-5967.

RADIO REPAIRMAN: 4 yrs. civ. & army exp. H. Zolinsky, 501 Powell St., B'klyn 12.

RADIO SERVING, 3 yrs. Army exp., aviation schooling, willing to learn. Lechatt, 641 E. 175 St., Bronx 57.

RADIO TECH.: comm. Army exp., AM, FM, television, accept apprenticeship program. Apt. 2D, 118 2d Ave., N. Y. 3.

RADIO MECH.: 2 yrs. AAF exp.; willing to learn. E. Bernat, 756 Saratoga Ave., B'klyn 12.

RADIO TECH.: 4 yrs. exp., AM & FM trans. & rec., accept apprenticeship. A. Rubin, 156 So. 9th St., B'klyn 11.

DE FDRST Student; desires position; postwar possibilities in radio servicing; 2 1/2 yrs. machinist exp. A. Brande, 531 W. 151st St., New York 31.

ELECTRONIC TECH. two years navy experience maintenance, installation radio, radar; knowledge trigger, video circuits; college grad. Box A-3. % Radio-Craft, 25 West Broadway, New York City.

EX-CAPT., 27 B.S., Army radio, radar background, extensive experience all phases wartime Loran program, pre-war industrial purchasing exp., can qualify for executive or purchasing assistant, sales engineering. Box A-4. % Radio-Craft, 25 West Broadway, New York City.

RADIO TECHNICIAN—22, three yrs. with AAF, interested all phase of electronics. Golnik to college nights. Robert Kreisler, 738 Saratoga Ave., B'klyn 12.

RADIO TECH., 27, exp. P.A., movie sound systems, allied field. N.Y.C. or L.A. L. Kruefer, 2660 E. 9th St., B'klyn 23, N. Y.

RADIO ENGINEER—1st class radiotelephone, 10 years amateur radio, 5 years diversified Army exp. Peter Kors, 168 Bay 26th St., B'klyn, N. Y.

A.A.F. RADIO-RADAR mechanic 3 yrs. exp. benchwork, test equip. Including oscilloscope, construct-align subherbs. A.C.-D.C. power units, etc. J. Goldstein, 969 Bruckner Blvd., Bronx 59.

ELECTRICAL-ELECTRONICS: 3 1/2 yrs. 1/c Navy electrician; willing to work and learn; desires opportunity night engineering student. Box A-2. % Radio-Craft, 25 West Broadway, New York City.

RADIO, RADAR, ELECTRONIC TECHNICIAN—Navy, 26. 2 1/2 yrs. exp., 1 1/2 yrs. college, stimulant personality. Desires position with progressive firm. Bull Navy transmitting and receiving base. Bernard Schmeltzer, 516 E. 11 St., N. Y. 9, N. Y.

RADIO TRAINEE—3 yrs. Army exp. Seeks work in electronic fields. Ago 24, earnest references. Box A-1. % Radio-Craft, 25 West Broadway, N. Y. C.

RADAR: know shifting of navy radar installation completely; electric welder, chauffeur. Robbins, 314 E. 19th St., B'klyn 3.

CREATIVE—that's the word for "Thinker Upper," radio program director, news editor, writer, public relations man with many interesting projects up his sleeve and—colorful record. (From PH D to Psychological Warfare.) Excellent references. Emil Lehman, 514 Third Ave., Astbury Park, N. J.

YOUNG VETERAN: 24, married, 3 1/2 yrs. service as radio mechanic and telephone linesman, willing to learn any electrical trade. Harry Joseph O'Brien, 55 Division Ave., B'klyn 11, N. Y.

LOGIC—A REPAIR TOOL

(Continued from previous page)

While the "channel substitute" approach is the method least used, it is often useful in locating "bugs" which are almost immune to the other methods of servicing. Intermittent reception, a bug causing no small amount of trouble to servicemen, can often be found by channel substitution.

SIGNAL TRACING

Signal tracing is, in the opinion of many (including the author) the ultimate in servicing. It is efficient because it deals with the item of primary importance, the signal. It requires a deep understanding of the theoretical principles of circuit function, and the ability to interpret correctly the indications given by the signal tracing instrument. Signal tracing is therefore only as good as the serviceman performing it.

It is an approach which involves following the signal from its input at the antenna to its output at the speaker, and determining at which point it is lost or distorted. For localizing hum, transient voltages, noise, and distortion, signal tracing is the last word in servicing.

Signal tracing may be accomplished with either an oscilloscope or a tuned VTVM (vacuum-tube voltmeter). This choice, like so many others in radio servicing, is largely a matter of preference.

With the oscilloscope, the signal in the receiver deflects the electron beam in the cathode-ray tube. A graphical representation of the signal voltage is thus obtained. These waveforms can then be judged for amplitude gain through a circuit or stage; for distortion, undesired attenuation or complete signal loss, transients, hum, and noise.

If the sweep frequency of the oscilloscope is not high enough to spread the waveforms, a broad band of light will appear on the scope screen when checking the signal in the r.f., i.f., or oscillator sections. This makes it impossible to determine the exact shape of the signal voltage. An amplitude measurement, however, is clearly indicated, and voltage gains and signal transfer may thus be noted.

The signal is followed from the antenna input, checked at all the grids and plates, and finally traced to the speaker voice coil. It may be checked at both sides of all coupling transformers and coupling condensers to see if the signal voltage is passed and if no distortion has been introduced. Fig. 5 shows the waveforms indicated at different points in the receiver.

In Fig. 5, A indicates the normal signal present at any point in the set's r.f. or i.f. sections. B represents the same signal after it has been amplified. The ratio of the height of signal B to the height of signal A is the voltage amplification between these two points of measurement.

C of Fig. 5 shows the i.f. or r.f. signal and the presence of super-imposed noise voltages. If these noise voltage peaks are regular and recurring, they

are probably caused by some mechanically rotating or vibrating device.

D of Fig. 5 represents the signal voltage at the plate or grid of the local oscillator. A straight narrow line with no vertical deflection at point D would reveal that the oscillator is inoperative. Incidentally, this same pattern (D) found in an audio stage would indicate undesired oscillation in that stage.

E of Fig. 5 is the signal expected to be found in the audio section. Once again the comparative amplitude of this signal at any two points is a measurement of voltage gain.

F of Fig. 5 represents the audio signal being distorted as a result of the tube operating beyond the linear portion of its characteristic curve. Overdriving the stage or improper bias on the tube will give rise to this condition.

G shows the signal in an audio stage which has harmonic distortion. Transformer and impedance coupled amplifiers are easily susceptible to this type of distortion.

The presence of power frequency hum is indicated in H of Fig. 5. In attempting to locate the origin of this hum, it is often wise to check the power supply and decoupling networks first.

While the cathode-ray oscilloscope is a versatile and widely applicable instrument of servicing, it is not expressly designed for the job of signal tracing. The "tuned vacuum-tube voltmeter" is designed solely for this purpose. The tuned VTVM's on the market differ slightly in design, but are identical in principle. They are known commercially as "Chanalysts," "Analysts," or by similar names.

The tuned VTVM picks up the signal at any point in the circuit, passes it through a detector circuit (if not already an audio signal), and actuates some indicating device such as a meter or magic-eye tube.

Fig. 6 illustrates this circuit arrangement. The signal is being picked up at any point in the r.f. oscillator, or i.f. sections, is then fed into a resonant circuit tuned to the signal frequency, amplified and passed through a detector, and the audio voltage shown by the indicating device.

If the signal is present, the indicating device will show this and give a measure of the signal amplitude. The frequency of the signal being checked is indicated by the calibrated dial of the resonant input circuit.

In checking the signal in the audio amplifier section, it is only necessary to amplify this signal and apply it to an indicating device. This indicating device may be an a.c. meter responsive to the audio frequencies. It may be a d.c. indicating device; in which case a rectifier or filter circuit must be employed to change the audio signal to a d.c. voltage. This arrangement is shown in Fig. 7.

The tuned VTVM is especially useful because it will not only trace the signal and measure its amplitude, but also indicate the signal frequency.

We have now discussed these three approaches to servicing: direct measurements, channel substitution, and signal tracing. As stated earlier the type of

ARMY AND NAVY SURPLUS BATTERIES

ALL NEW — IN ORIGINAL CASES

Signal Corps Type	Mfg. Type	Description	Quantity per Case	Case Price Only
BA-2	Burgess 4156	22½ Volt "B" 3" x 3⅜" x 2⅞"	40	\$0.07 each
BA-27	Burgess 2370	4½ Volt "C" 3⅜" x 4" x 1⅜"	54	.07 each
BA-30	Burgess #2 Eveready 950	1½ Volt Flexible Cell	600	.02 each
BA-35	Burgess 4FH Eveready #6	1½ Volt "A" Screw Terminals	32	.07 each
BA-36	Burgess 5308 Eveready 762-S	45 Volt "B" 5⅞" x 4⅜" x 2⅞"	12	.12 each
BA-39	Burgess 5A100 Eveready 349	Combination Form 6 Pack 7½ Volt "A" 150 Volt "B"	6	.25 each
BA-48	Burgess 6TA60	Portable Combination "A"- "B" Pack 1½ Volt "A"-90 Volt "B"	20	.35 each
BA-53	Burgess Z30N Ray-O-Vac 452	45 Volt "B" Screw Terminals with Insulated Junior Knobs 1⅞" x 3" x 4⅞"	32	.12 each
BA-59	Burgess M-30 Eveready 482	45 Volt Portable "B" 5⅞" x 3⅞" x 1⅞"	24	.35 each

RADIO ELECTRIC SERVICE CO., INC.

N. W. COR. 7th AND ARCH STS., PHILADELPHIA 6, PA.

BRANCHES

3145 N. Broad St., Philadelphia, Pa.
5133 Market St., Philadelphia, Pa.
513-515 Cooper St., Camden, N. J.

219 W. 8th St., Wilmington, Del.
1042 Hamilton St., Allentown, Pa.
9 North Second St., Easton, Pa.

IMMEDIATE DELIVERY!

APPROVED Model A-100 SIGNAL GENERATOR



Complete with all tubes, connecting cables, instructions, etc. Battleship gray enameled finish. Size: 12 x 10 x 6½".

- 6 R.F. BANDS
100 Kc.-316 Kc., 316 Kc.-1000 Kc., 990 Kc.-3200 Kc., 10.6 Mc., 10.6 Mc.-26 Mc., 21.2 Mc.-52 Mc.
- CONTINUOUSLY VARIABLE RF-AM fine attenuator control.
- EXTERNAL MODULATION FROM 40 to 30,000 cycles.
- INTERNAL MODULATION AT 440 cycles.
- NEGLIGIBLE HARMONIC OUTPUT.

Net Price . . . \$47.00

—Circular on Request—
C.O.D. orders should be accompanied by 25% deposit.

SCENIC RADIO & ELECTRONICS CO.

53 Park Pl., New York City 7

approach should be compatible with the serviceman's type of mind. In recent years the trend has been towards signal tracing. This approach is becoming more and more widely used. In radio work any of the three approaches can be made successfully. In electronics, radar, television, and any other circuits containing, non-sinusoidal waveforms, signal tracing with an oscilloscope is not only commendable but practically a necessity.

CORRECTION

An error appeared in the article, A.C. Voltage Measurements, on page 250 of the January issue. The fourth equation of a series relating to Figure 4 reads $I_2 = I_m + I_s$. This equation should read, $I = I_m + I_s$.

Our thanks to Mr. L. W. Lehtreck, of St. Louis, Mo., for calling this to our attention.

VELOCITY
P.G. DYNAMIC

THE FINEST MICROPHONES

AMPERITE

FOR PUBLIC ADDRESS & RECORDING

MICROPHONES THAT SURPASS THE HIGHEST REQUIREMENTS OF BROADCASTING, PUBLIC ADDRESS, AND RECORDING

Write for Catalog

AMPERITE COMPANY

541 BROADWAY • NEW YORK, N. Y.

HARD-TO-GET PARTS

POWERFUL ALL-PURPOSE INDUCTION MOTOR

IDEAL FOR EXPERIMENTERS—101 USES



Sturdily constructed to precision standards, this self-starting shaded pole A.C. induction motor is powerful enough for a number of uses. Some of these are: Automatic Timing Devices, Current Interrupters, Electric Fans, Electric Grinders, Window Displays, Photo Cell Control Devices, Electric Vibrators, Small Grinders, Buffers and Polishers, Miniature Pumps, Mechanical Models, Sirens, and other applications.

Consumes about 15 watts of power and has a speed of 3,000 r.p.m. When geared down, this sturdy unit will constantly operate an 18-inch turntable loaded with 200 lbs. dead weight—THAT'S POWER!
Dimensions 2" high by 1 1/2" deep; has 4 convenient mounting studs; shaft is 3/16" diameter and runs in self-aligning oil-retaining bearings. Designed for 10-20 volts, 50-60 cycles, A.C. only. Shp. Wt. 2 lbs.

ITEM NO. 147
YOUR PRICE \$2.95

ULTRA MAGNET

LIFTS MORE THAN 20 TIMES ITS OWN WEIGHT

LITTLE GIANT MAGNET

Lifts 5 lbs. easily. Weighs 4 oz. Made of ALNICO new high-magnetic steel. Complete with keeper. World's most powerful magnet ever made. The experimenter and hobbyist will find hundreds of excellent uses for this high quality permanent magnet. Measures 1 3/4" x 1 1/4". Shp. Wt. 3 1/2 lbs.

ITEM NO. 159
YOUR PRICE \$1.50



GENUINE MICROPHONE TRANSMITTERS

Regular telephone transmitters taken from a large telephone supply company's overstock. Work superbly on 2 dry cells. Can be used on P.A. systems, call systems, intercommunications, etc., a short-line telephone circuits, house-to-house or farm-to-farm phone lines, also to talk through your own radio or as concealed dictating devices. Useful replacements on battery-operated rural telephone lines.

THESE ARE GENUINE TRANSMITTERS, MADE BY KELLOGG, WESTERN ELECTRIC AND WESTERN TELEPHONE-CALSON, excellent in appearance and operation. A remarkable value and one seldom offered in these times. Shp. Wt. 1 lb.

ITEM NO. 160
YOUR PRICE \$1.50

AMAZING BLACK LIGHT!!

Powerful 250-Watt Ultra-Violet Source

The best and most practical source of ultra-violet light for general experimental and entertainment use. Makes all fluorescent substances brilliantly luminescent. No transformers of any kind needed. Fits any standard lamp socket. Brings out beautiful fluorescent hues in various types of materials. Swell for amateur parties, plays, etc.; to obtain unique lighting effects. Bulb only. Shp. Wt. 1/2 lbs.

ITEM NO. 87
YOUR PRICE \$1.95

WESTERN ELECTRIC BREAST MIKE

This is a fine light-weight aircraft carbon microphone. It weighs only 1 lb.

Mike comes with breastplate mounting and has 2-way swivel adjustment so that it can be adjusted to any desired position. There are two wires; one goes around neck, the other around chest. Straps can be snapped on and off quickly by an ingenious arrangement.

This excellent mike can be adapted for home broadcast, private communication systems. By dismantling breastplate, it can be used as desk mike.

Comes complete with 6-foot cord and hard rubber plug. Finished in shrapnelized plate, non-slipable. Shipping weight, 2 lbs.

ITEM NO. 152
YOUR PRICE \$1.95

WATTHOUR METER

Completely overhauled and ready for immediate service. Designed for regular 110-volt, 60 cycle 2-wire A.C. circuit. Simple to install; 2 wires from the line and 2 wires to the load. Sturdily constructed in heavy metal case, 8 1/4" high, 6 1/4" wide, 5 1/2" deep. Waiting house, G. E., Westinghouse, Sangamo or other available make. Shp. Wt. 1 1/2 lbs.

ITEM NO. 33
YOUR PRICE \$4.95

HUDSON SPECIALTIES CO.

40 West Broadway, Dept. RC-5-46, New York 7, N. Y.

I have circled below the numbers of the items I'm ordering. My full remittance of \$5.00 (NO C.O.D. ORDERS UNLESS ACCOMPANIED WITH A DEPOSIT.) or my deposit of \$5.00 (C.O.D. is enclosed (20% required, ship order C.O.D. for balance. NO C.O.D. ORDER FOR LESS THAN \$5.00. BE SURE TO INCLUDE SHIPPING CHARGES. Circle item No. wanted.)

147 159 160 87 152 33

Name

Address Please Print Clearly

City State

A VERSATILE VTVM

(Continued from page 535)

within the linear portion of the characteristic while still impressing a greater voltage on the grid than would otherwise be possible.

AN EXPERIMENTAL HOOKUP

A few calculations plus a breadboard experimental setup soon showed that with a value of cathode resistor sufficient to provide about 2.2 volts of bias, a voltage loss of about 80 percent resulted. Fig. 1 illustrates the preliminary circuit tried. With R1 set near the value of the cathode resistor and with one volt actually impressed between grid and ground, the meter would deflect about three-quarters of full scale. Reducing the size of R1 made it possible to obtain full scale deflection with a one-volt signal. The unhappy feature was that the meter reading was not linear. When half a volt was applied, the meter did not read 0.5. Further checks showed that in Fig. 1 the cathode-to-grid change was about 0.8 of a volt when one volt was impressed across the grid. In other words, the linear portion of the tube characteristic was being exceeded. The cure for that was to increase the size of the cathode resistor. This would make the cathode follower more efficient and therefore there would be a larger cathode swing and consequently less difference between grid and cathode.

voltage on both sides of the meter, obviously no current will flow through it. When a potential of one volt is applied between grid and ground several things happen all at once. First, the grid rises one volt. Then the voltage at the cathode rises about 0.5 volt with reference to ground, since the tube passes more current. This causes a current of one milliamperere to flow through R1—roughly one milliamperere. The exact current that flows depends on the setting of R1. This extra current must also flow through the 125-ohm biasing resistor. This tends to lower the cathode-to-ground voltage slightly—by .125 volts to be exact. When equilibrium is reached—and this all happens practically instantly—the cathode is established firmly 0.4 of a volt higher than it was previously. This extra voltage has caused enough current to flow through the meter to bring it to full scale deflection. The meter does not wind itself around the needle stop because the current that flows through it also flows through R1 and raises the voltage at that point almost 0.4 of a volt. The cathode to grid voltage has changed only 0.6 of a volt. Tests showed that the response was linear which was to be expected since the "signal" was within the linear portion of the tube characteristic.

It can be shown that the output impedance of a cathode follower is considerably less than the actual value of cathode load. This means that a cathode follower can be comparatively heavily loaded without changing the amplitude of its output.

Because a low value of R1 will require more current to produce a given value of voltage drop across it than a high value, R1 can be used as a sensitivity control. Within reasonable limits its value will not affect the operation of the cathode follower. When R1, for instance, is set at 200 ohms, an extra current of one ma through it will cause a voltage rise across it of 0.2 of a volt. A 300-ohm value would cause a voltage rise of 0.3 of a volt. It can be readily seen that the voltage at the cathode would have to be higher to maintain the same meter reading if R1 was 300 ohms than it would if R1 were only 200 ohms.

R1 will require initial setting when the unit is built and readjustment whenever the tube is changed. It should not be necessary to adjust it very often. In the four months this unit has been in daily operation, it

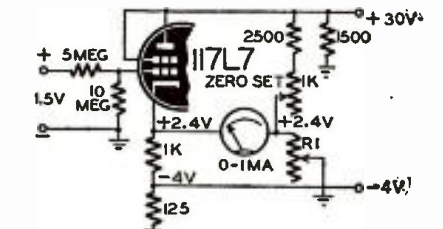

Fig. 2—Fundamental circuit of the meter.

A value of 1000 ohms was selected. It was found that to keep the bias on the tube near the 2.5-volt region, some circuit changes would have to be made. Either the grid would have to be placed above ground, or the cathode resistor would have to move to the sub-basement. The circuit shown in Fig. 2 was there-

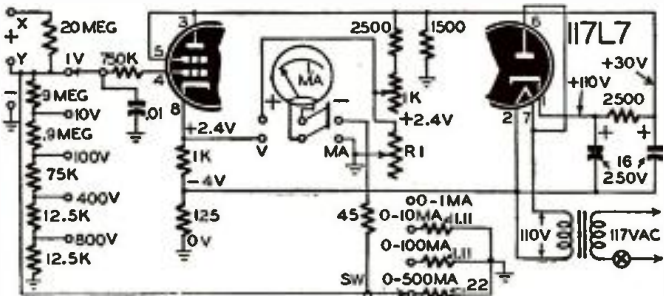

Fig. 3—Schematic of the volt-milliammeter as finally adopted.

fore adopted. The voltage distribution is as indicated. The grid-cathode voltage difference is maintained at 2.4 volts.

HOW IT OPERATES

If the thousand-ohm zero-set control is adjusted to provide exactly the same

has not been found necessary to change the setting of R1. A setting of between 200 and 400 ohms will be found to be correct for almost any tube used. Remember, to increase sensitivity, lower the value of R1.

(Continued on following page)

The final voltmeter circuit is shown in Fig. 3. The transformer was wound by hand on a core from a small power transformer. About 600 turns of No. 26 enameled wire were used for the primary and about 500 turns for the secondary. It was a tiresome job, but no small transformer with a slight step-down ratio was to be found. It would be unwise to build the unit without a transformer, though at first thought it would seem that dropping resistors could be used. The transformer is needed for isolation, and if it is being hand wound it might just as well drop the voltage a little too, thus saving the cost of a resistor. Without the transformer, one side of the a.c. line would be connected through the 125-ohm biasing resistor to the negative probe of the electronic meter. If this probe were then to be clipped to the chassis of an a.c.-d.c. receiver and the line plug happened to put the receiver chassis at the opposite polarity to the voltmeter, it would not be so good. There would be 110 volts across the biasing resistor, which would quickly lead to a lot of smoke and a burned-out resistor.

CALIBRATING THE UNIT

After the unit is built, it must be calibrated. The easiest way to do this is with a couple of storage batteries, though dry batteries can be used. If storage batteries are available, connect them in series so that 10 volts is available in two-volt steps. Accuracy of calibration will depend on the exactness of the voltages, so it would be wise to check them with the best meter available. If they are fully charged, each cell may provide a potential of slightly more than two volts, and allowance should be made for this in the calibration. A light load across the batteries will bring them down to an almost exact 2 volts.

If the unit has been constructed in accordance with Fig. 3, be sure that the volts-milliamperes switch is set for volts. Plug the unit in the a.c. line, and set the selector switch to the 10-volt scale. Use terminals Y and the common negative if storage batteries are used for calibration; terminal X and the common negative if dry batteries are used. After allowing the unit plenty of time to warm up—at least five to ten minutes—accurately set the meter with the 1000 ohm zero-set. Then place the meter probes across the 10-volt source and observe the reading. If the meter needle reads more than full scale, increase resistance R1. If the meter needle reads less than full scale, decrease the resistance provided by R1. Once the value of R1 which gives full-scale deflection is obtained, the linearity can be checked by connecting the meter probes to successively lower voltages. Be sure that the zero-set is accurately made since it will require resetting when R1 is changed.

If dry batteries are used the same procedure can be followed with the exception that a total of 30 volts should be available for a complete check on the linearity. Terminals X and the common negative should be used.

The other ranges can be checked with

known voltages of the proper magnitude. If the resistors in the input circuit have been carefully selected, a rough check to make sure of correct wiring would be all that is required.

The calibration just described is simple and reasonably accurate and can be done quite quickly. It should be accurate enough for all practical purposes.

THE MILLIAMMETER CIRCUIT

Current scales can be included or not as the builder desires. The simplest way to obtain the proper value of shunts is to use another milliammeter as a standard in series with this one. With a voltage source of the proper magnitude—a dry cell and variable resistor will do quite nicely—the selection of the shunts is quite simple. From a discarded potentiometer select resistance wire of about the right length. Connect it as a shunt across the terminals of the meter in this unit. Then apply the voltage to both meters in series and adjust the variable resistor controlling the voltage until the standard meter reads the desired current. Then vary the length of resistance wire used as a shunt until both meters read the same. The resistance wire can be wound around any convenient form and cemented after the proper length has been determined. The same procedure can be followed on the other ranges. It may be advisable to use copper wire on the highest range since a resistance of only 0.22 ohms is approximately what will be needed. It is easier to work with and easier to solder, though it has the slight disadvantage that its resistance tends to increase slightly as its temperature rises.

The values listed in Fig. 3 are correct for a meter with an internal resistance of 100 ohms. The 45-ohm resistor in series with the meter brings the resistance of the particular meter used in my unit to 100 ohms.

If the circuit is carefully followed and close-tolerance resistors in the input network for the voltmeter selected, the builder of this unit will have a voltmeter that should compare favorably with the most expensive commercial models.

OSCILLOSCOPE

Western Electric used Signal Corps 5" oscilloscope made for SCR 268 Radar set. Contains power supplies 115 volt, 60 cycle; amplifiers and controls for vertical and horizontal positions, sensitivity, spread, focus intensity, and fixed frequency sweep. Contains 13 tubes. Comes complete with diagram showing how to add a sweep circuit. Excellent for radio servicing and laboratory experimenting. Model BC 412 A and B. Shipping weight 200 lbs. all complete. ONLY **32.50**

Maritime Switchboard

336 Canal Street New York 13, N. Y.
Worth 4-8217

METERS

NEW WESTON RADIO SERVICE METERS
IMMEDIATE DELIVERY

Model 779	\$69.19
The Newest Supersensitive Analyzer	
Model 772 analyzers	\$49.50
Model 777 Tube checkers	\$49.50
Model 697 analyzers	\$24.00
Model 785 Industrial circuit tester..	\$93.75
Model 666 selector	15.83
Model 766 Televerter. 5,000 volt	18.75
Model 766 Televerter. 10,000 volt ...	22.00

NEW SURPLUS METERS

WESTON ROUND FLUSH BAKELITE
METERS UNLESS SPECIFIED
OTHERWISE

Model 301, 3 1/2" 0-10, 0-15, 0-50, 0-100, 0-300, 0-1000 Milliampere D.C. ...	4.95
Model 301, 3 1/2" Sangamo 500-0-500 Microampere Movement, 100-0-100 Scale	3.95
Model 506, 2 1/2" 0-10, 0-50, 0-200 Milliampere, D.C.	3.50
Model 643, Surface Mounting. 0-150 volts D.C.	8.00
Model 301, 3 1/2" voltmeters 0-150 volts D.C.	4.50
0-1 1/2 K.V., D.C. complete with 1000 ohm per volt resistor	6.95
0-4 K.V., D.C. complete with resistor	7.95
Model 476, 3 1/2" 0-8 volts \$4.00. 0-130 volt \$4.50. 0-150 volts	5.95
Model 517, Round Flush Ring Mounting, 0-15-25-75 volts A.C.	2.95
Model 517, 2 1/2" 0-150 volts A.C.	2.95
Model 476, 3 1/2" 0-4 Ampere White-scale	4.50
0-30 Ampere A.C. Black Scale	4.00
Model 642, 4 1/2" Surface mounting. 0-150 volts A.C.	9.00
0-15 Ampere A.C.	8.00
Model 301. 0-25 volts A.C. Rectifier type 2000 ohm per volt	6.95
Model 506, 2 1/2" Decibel Meter -10 to +6 Black Scale	3.95

WESTINGHOUSE

Model NA 33, 2 1/2" 0-150 volts A.C. ..	1.98
Model NX 35, 3 1/2" 0-24 Milliampere movement, with 0-24 MA and 0-1200 volt scale	2.25
Model RX 35, 3 1/2" 0-15 kilovolt meter, 1 milliampere D.C. movement, complete with 15 megohm, 15 kilovolt tubular resistor. List price \$165.00. YOUR cost only	16.50
Model DY-2, 4 1/2" 0-2 1/2, 0-50, 0-60, 0-70, Ampere A.C. surface mounting White Scale	8.00
Model DY-2, 4 1/2" 0-150 volts A.C. surface mounting Black Scale	9.00
Model DY-2, 4 1/2" 115 volt, 50-70 cycle frequency meter White Scale	35.00
GE Type DW44. Radio Frequency ammeter. 2 1/2" Black Scale 0-1 and 0-8 Ampere	2.95
Model DO-40, G.E. 3" Round Surface Mounting Meters. 0-2.5 and 25 milliamperes, 0-300 Milliampere, 0-300 volts. All D.C. All ZERO CENTER	2.50

Add sufficient postage on P.P. orders.
Excess will be refunded.

Maritime Switchboard

336 Canal St. N. Y. 13, N. Y.
Worth 4-8217

LEEDS

The Home of RADIO

For over 25 years exceptional values and service to customers all over the world.

Here Again . . .

BC-412 "Scope" complete with 11 tubes plus 5" Cathode, operates on 110 V. A.C. **\$35.00**

BC-603 Tank Receiver, cost Govt. \$900.00; FM freq. range 20 to 27.9 mc. Can be converted. Extra Special. Order at **\$5** once

Selayn Motors, 110 V., 60 c., with indicator. Extra **\$18.00** Special. Pair

- BC-423 Modulator
Self contained power supply can be easily converted to a 2 meter transmitter. Complete with tubes\$10.00
- BC-156 Transmitter & Receiver
Complete with phones, generator, antenna and ground, spare parts, etc. All in trunk 39" x 22" x 10 1/2" 25.00
- TS/182 UP Navy Scope
An exceptional buy. Complete with tubes and set of spare parts including transformer, choke, 2 extra cathodes and 22 other tubes 60.00
- .05 Mfd. 16000 V Sprague Vitamin "Q" oil condensers 3.00
- .5 mfd. 5000 V. GE Pyranol 5.00
- 10 mfd. 1000 V. GE Pyranol 2.75
- Aerovox Oil Condensers, 1 mfd., 1000 volts95
- Signal Corps High-grade Telegraph Key89
- High Grade Transmitting Key89
- \$12.50 G.E. Pyranol, 10 mfd., 600 V. Cond. 1.50
- G.E. Pyranol, 4 mfd., 600 V. Cond95
- Shure Crystal Pickup 2.75
- 1 mfd. 600 V. Aerovox Oil-Filled Bath-tubs25
- \$60.00 Aerovox 1 mfd. 10,000 V. Oil Cond. 9.95

LEEDS RADIO CO.

75 Vesey Street
COrtlandt 7-2612 New York City 7

MIND POWER

A FREE BOOK

Develop your personal, creative power! Awaken the silent, sleeping forces in your own consciousness. Become Master of your own life. Push aside all obstacles with a new energy you have overlooked. The Rosicrucians know how, and will help you apply the greatest of all powers in man's control. Create health and abundance for yourself. Write for Free book, "The Mastery of Life." It tells how you may receive these teachings for study and use. It means the dawn of a new day for you. . . Address: Scribe, U.S.V.

The ROSICRUCIANS
SAN JOSE (AMORC) CALIFORNIA

PLUG-UGLY ELIMINATOR

By MAURICE A. KAY

THE object of the invention is to provide a means by which a person listening to the radio can be relieved of listening to commercial announcements in which he may have no interest or which may even be offensive to him.

It operates by the listener pressing a button whenever the announcer begins his commercial. This shuts off the current to the set and eliminates the commercial. After a predetermined time interval, the current is automatically turned on without effort by the listener and the broadcast is resumed.

Many persons turn off their radios whenever a commercial announcement comes on. Especially those obnoxious ones—babies crying, whistles and fog horns blowing, etc., etc. Often the person either forgets to turn the radio on again or turns it on while the announcer is still proclaiming.

To perform the operation described above, I use an apparatus consisting of a baseboard which supports a case in the top of which is located a switch. The switch has a stem which when pressed closes an electrical circuit. The switch is so constructed that it is open unless restrained by pressure on the stem.

Mounted on the baseboard is a cylinder adapted to receive a pump piston which slides horizontally therein. The piston has a rod which projects through a cover in the cylinder. A spring tends to force the piston forward so that the upper end of the piston rod strikes against the stem of the switch and closes the circuit. Normally the spring holds the switch closed by pressing on the stem of the switch through the piston and the piston rod.

A regulating valve is provided at the

bottom of the cylinder regulating the flow of air to the space inside the cylinder. By screwing this valve in or out, the rate at which the air can enter the cylinder may be regulated.

Secured to and moving with the piston rod is a bent arm, one end of which is attached to the piston rod. The other projects through a slot in the case. This slot has a notch formed therein. This

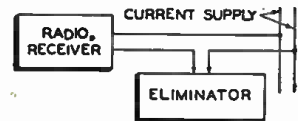

Block diagram of the commercial eliminator.

bent arm has at the end a finger button and a pointer which registers on a scale.

When the listener hears the announcer start a commercial, he simply presses the finger button. The bent arm to which the finger button is attached pulls down the piston rod, causing the switch to open and abate the nuisance. As the

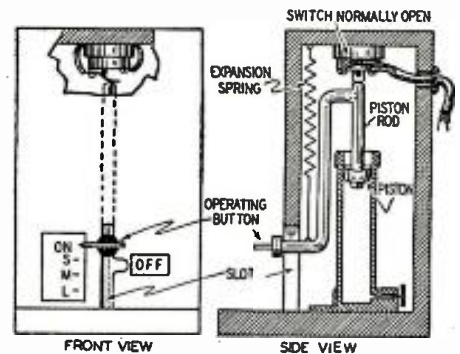

Working diagram of the apparatus which is claimed to be radio's greatest improvement.



Left—The inventor shows how the eliminator operates. Right—Inside view of the device.

piston is forced downward, the air is forced outward through the valve and around the sides of the piston. When the button is released, the spring forces the piston back. This motion creates a vacuum below the piston which resists further movement until sufficient air enters the cylinder through the valve and partially balances the pressure on both sides of the piston. The piston rod continues its travel until the upper end closes the switch after an interval of, say, 45 seconds after the button is pressed by the listener. The listener may regulate the length of the interval by adjusting the valve. He can, without adjusting the valve, regulate the length of the interval by varying the distance he pushes the button down, being guided by the calibrations on the scale. The listener can turn off the set permanently by placing the finger button within the niche on the slot.

The apparatus is small and portable. By using wires of sufficient length, the apparatus may be placed by the listener in any convenient location without moving the receiver, or the apparatus may be made an integral part of the radio receiver.

The device is connected to the radio by means of a "series" plug fixed to the terminals of the wires leading to the commercial eliminator. This series plug fits into the electric wall outlet near the radio. The plug from the radio is then fitted into the series plug. Thus the current to the radio is controlled through the switch in the eliminator. When the eliminator is not operated the current is controlled by the switch on the radio itself as in normal operation.

RADIO-ELECTRONIC QUIZ

How thoroughly have you mastered the contents of this magazine? Try the following quiz as a test:

1. How might the range of one television station be extended to cover half the earth? (See page 530.)
2. What does "Block" and "Ring" mean to television? (See page 531.)
3. What is a "Vectorscope"? (See page 533.)
4. What would be necessary to attain absolute linearity in a vacuum-tube voltmeter? (See page 535.)
5. How many sets of computations are required for a five-antenna array? (See page 536.)
6. How is the frequency of an FM transmitter stabilized? (See page 537.)
7. Of what use is a frequency-modulated signal generator when servicing an AM receiver? (See page 540.)
8. What are the three main approaches to radio receiver servicing? (See page 543.)
9. Can you name a reflector which contains no solid material, yet can be used to swing the beam of a radar or radio transmitter? (See page 562.)
10. Has a device ever been made which will cope successfully with the "plug-ugly" radio commercial? (See page 580.)

SPEED UP REPAIRS WITH THESE G-C AIDS!

Handle Dial Belt Replacements the Easy G-C Way!

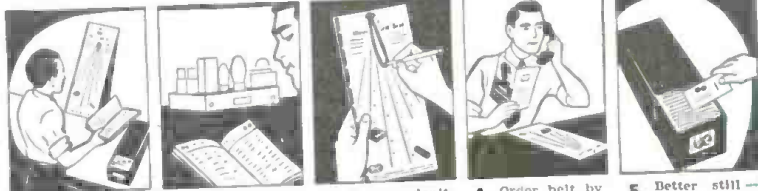

1. To determine proper belt for any radio, G-C supplies a complete Belt Replacement Guide and Measuring Scale.
2. By using G-C Belt Guide, just check model number of the set to determine correct G-C Belt.
3. If you don't know model number or make of the set, use G-C Measuring Scale and simple instructions to measure belt.
4. Order belt by number from your radio parts distributor. Phone or mail your order to receive prompt service—no waiting.
5. Better still—have a complete G-C Belt Kit on hand. Belts are indexed in permanent steel box with slide-in drawer.

FREE TO ALL RADIO SERVICEMEN — 68 page G-C No. 345 Belt Guide and Service Book and Measuring Scale. Ask for them at your Radio Parts Distributor.

Get "Smooth-Strong-Correct Fit" G-C Dial Belts from Your Radio Parts Distributor



GENERAL CEMENT MFG. CO.
ROCKFORD, ILLINOIS



MINIATURE, EXTRA-SENSITIVE HEADPHONES!

IDEAL FOR

Amateurs, Servicemen, Commercial Operators, etc.

Manufactured especially for Infantry and Armored Forces; cost the Government approx. \$35.00 per headset. Extremely sensitive phones, with good fidelity characteristics, with matching transformer built-in so that phones work into any hi-impedance output and at the same time are protected from any DC component. Practically indestructible. Light and Compact! Features: adjustable headband; flexible rubber phone cord to provide many years of wear and to guard against moisture; rubber spring clip for fastening to clothing; soft, flexible rubber ear-tips fastened to each phone for comfort and to remove extraneous noises, etc. Supplied with standard phone plug.

PRICE, **5⁹⁵**
COMPLETE

Send check or money order for postpaid delivery. Dealer and distributor inquiries invited on quantity.

TAYBERN EQUIPMENT COMPANY
120 Greenwich St. New York 6, N. Y.



NEW TINY POCKET SIZE RADIO!

Slips in your pocket or purse—WEI only 3 ozs! Complete, READY TO PLAY as shown with self-contained phone for personal use. Smooth, durable black and silver plastic case. New patented Fixed Crystal—NO TUBES. BATTERIES OR ELECTRIC PLUG IS REQUIRED. USUALLY RECEIVES LOCAL BROADCASTS CLEARLY without outside aerial wire. GUARANTEED TO WORK when connected and used according to instructions sent with each radio. Can be used in homes, offices, hotels, cabins, bed, after hours, etc.

SEND ONLY \$1.00 (cash, money order, check) and pay postman \$2.99, plus delivery fees on arrival or send \$3.99 for postpaid delivery. IDEAL GIFT FOR CHILDREN OR ADULTS ALIKE! Get your PA-KETTE RADIO TODAY—NOW. Dealers in most cities.
PA-KETTE RADIO COMPANY
DEPT. RC-5 KEARNEY, NEBRASKA

MORE SMASH BUYS at National Radio Distributors

IMMEDIATE DELIVERY

HERE'S VALUE!

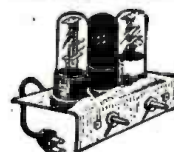

3 tube AC-DC Phono Amplifier, completely assembled and ready to operate. Uses 12SQ7, 50L6 and 35Z5 tubes. Size: 3 1/2" x 3 1/2" x 1 1/4". Price each \$4.75 net less tubes. In lots of 10 each \$4.45.

A GREAT BUY—INSULATED RESISTOR KIT. Contains 100 1/2, 1 & 2 Watt New BT type Metalized insulated resistors. Approximately 60 different popular sizes. Some Gold Band. Each \$2.69. In lots of 10 each \$2.25.

EXTRA SPECIAL!—BY-PASS CONDENSER KIT. Consists of 100 Tubulars (all 600 Volt) in the following sizes: .001, .002, .006, .01, .02, .03, .05 & 1 Mfd. All Fresh Stock, and fully guaranteed. Per Kit, \$5.95.

RADIO KITS—4 Tube T.R.F. Complete, including tubes, new Alnico 4" Speaker, and full instructions. Each \$19.95.

5 TUBE SUPER-MET—Complete including tubes, Dynamic Speaker, and full instructions. Each, \$17.95. Please include at least 25% with C.O.D. orders. Write for New Free Catalog. Just Out!

National Radio Distributors

1029 E. 163 St., New York 59, N. Y.

"QUALITY ABOVE ALL"



CAPACITORS

SOLAR CAPACITOR SALES CORP.
285 MADISON AVE. • NEW YORK 17, N. Y.

CHECK THESE PRICES!

HERE ARE JUST A FEW OF OUR SENSATIONAL VALUES ON OUR LARGE STOCK OF STANDARD FIRST-QUALITY MERCHANDISE. SEND FOR OUR LATEST PRICE LIST.

Almost all types of tubes in stock. Mail in your orders for all types needed, not just the critical numbers, and we'll try to fill your orders completely!

TANK TRANSMITTER owners! Trade in your 12-volt dynamotor for a 110V AC operated power supply. For \$24.95 and your dynamotor, we will supply a complete kit of parts and instructions to construct a power supply operating from 110 V AC. for your B-19, Mark II Radio. Complete SCHEMATIC DIAGRAM and CIRCUIT DESCRIPTION for B-19's, along with instructions to convert to AC operation—\$5.00.

TUBULAR CONDENSERS. Guaranteed one year. Prices in lots of ten, either one type or assorted. 100 Mf.—35c; 50 Mf.—35c; 150V.—35c; 20-30 Mf.—150V.—40c; 20-20 Mf.—150V.—35c; 25 Mf.—25c; 20 Mf.—150V.—20c; 10 Mf.—50V.—15c. PAPER CONDENSERS 1000V test; 600 WV. 25 Mf.—20c; 1 Mf.—10c; .05 Mf.—9c; .02 Mf.—8c; .01 Mf.—8c. .008 Mf.—5c; .005 Mf. and smaller—7c. MICA CONDENSERS. 1000V test; 800 WV. any standard capacity—15c. MOTOR STARTING CONDENSERS. 110V. 85-115 Mfd. 3-second start, universal type for refrigerators, pumps, etc.—\$1.25.

PLASTIC LONG-NOSE PLIERS—Will stand 300° heat and are insulated to 6000V. Just the tool for radio servicing—80c. **AMPLIFIER FOUNDATION UNIT 7x17x9"**, chassis is 3" high. Finished in beautiful gray ripple finish—\$2.70. We have a complete stock of ICA chassis and cabinets at comparably low prices. G.E. MICROSWITCHES, S.P.D.T.—50c. FILTER CHOKES—Stromberg-Carlson. 30 Hy. 250 Ma. 35 Ohms DC Res. Fully shielded in black crackle case—\$1.98.

RADIO CHEMICAL KIT—In leather case—contains one bottle each of cabinet stain, dial-drive "no-slip," contact cleaner, lubricating oil, cabinet polish, and service cement—"As useful as a screwdriver to the serviceman"—\$1.34 per kit. SPAGHETTI—in assorted colors—first quality—will fit insulated wire up to #10 size—25 ft. for 25c. METER RECTIFIERS—full wave, four-wire type—99c ea.

ALL PURPOSE NEON TESTERS. 60 to 550 volt. Indicate all kinds of current, AC, DC or RF, and comes complete with instruction booklet outlining various tests on radio sets, including the location of fading, dead stages, shorts, and making screen-grid and plate circuit tests. 25c ea. Per doz. on attractive display card—\$3.50.

AUTOMOBILE ANTENNAS—Standard 3 section type, complete with lead-in—60"—\$1.50; 90"—\$2.95. RESISTOR KITS—50 assorted, all useful 2 Watt size—\$1.95. ROTARY SWITCHES—SPDT shorting type—15c. Ceramic switches for hi-frequency use—3 pole double throw or 4 hole double throw (shorting type)—either one—45c. "INSIDE THE VACUUM TUBE," by Rider—a valuable addition to your technical library—\$4.50.

CARBON MIKES: "Home Broadcast" type, complete with instructions to attach to any radio—60c. Gold-plated single-button midket type signal corps mike, with stretched duraluminum diaphragm—Just the mike for concealed or secret pickups, lapel mikes, or for attaching to any radio—95c ea. SHURE, Model T-17, single-button. Features high-quality reproduction, built-in switch, 5-ft. cable with plug, and moistureproof cover. Packed in sealed cartons—\$2.75. Bullet CRYSTAL mikes, \$5.45; Bullet DYNAMIC mikes—\$7.45.

RECORD CHANGERS—110V, 60 cy, with crystal pickup. This two-post changer will play twelve 10 or 12 inch records INTERMIXED!—the only changer on the market with this feature. In this price range. Specially priced at \$22.50.

BUFFALO RADIO SUPPLY

219-221 Genesee St., Dept. 5C
Buffalo 3, N. Y.

Do you need

BINDING POSTS?



The XL PUSH POST with its Spring Action assures Constant Contact and quick connection. Manufactured in All Aluminum Type M at 12c each. Aluminum Body, Bakelite Top Type B! at 15c each. TYPE NP, ALL BRASS—STAINLESS STEEL SPRING & PIN. PROVEN by 240 HR. SALT SPRAY TEST as NON-CORROSIVE at 25c each. Manufacturers and Dealers Liberal Discounts

X. L. RADIO LABORATORIES
420 West Chicago Ave., Chicago 10, Ill.

Ted McElroy
World's Largest Manufacturer of
Wireless Telegraphic Apparatus
COMPLETE CENTRAL OFFICE EQUIPMENT
McElroy Manufacturing Corp.
82 Brookline Avenue • Boston, Massachusetts

Available Radio-Electronic Literature

Manufacturers' bulletins, catalogs and periodicals.

A NEW SERVICE FOR RADIO-CRAFT READERS: In order to save your time, postage and incidental work in writing a number of letters to different manufacturers to secure the various bulletins offered, proceed as follows:

On your letterhead (do not use postcards) ask us to send you the literature which you designate. It is only necessary to give us the numbers. We will then send your request directly to the manufacturers, who in turn will send their bulletins or other literature directly to you.

210—MANUAL FOR ELECTRONIC DEMONSTRATION

An interesting manual of laboratory experiments, printed by Radiolab Publishing and Supply Company. A 60-page booklet of nine chapters, illustrating methods of performing 15 experiments or demonstrations of electronic principles. The demonstration begins with the flow of electrons and conclude with receiver testing and alignment.

This manual is of particular interest to science and physics teachers. The demonstrations described may be altered to fit the needs of the class or the equipment on hand. Presented upon purchase of servicing equipment but may be purchased separately for \$2.00.

211—INSTRUMENT CATALOG

Electro-Tech issues a 24-page catalog of servicing and industrial equipment. The catalog is well illustrated and lists a line of standard equipment.—*Gratis*

212—STUPAKOFF CATALOG

Stupakoff Ceramic Manufacturing Company issues an illustrated bulletin showing the various ceramic products manufactured. These products include antenna spreads, coil forms and insulators. They are also manufacturers of metal-glass hermetic seals.—*Gratis*

213—PRECISION SWITCHES

A switch manual by the Mu Switch Corporation. This manual is well illustrated with photographs and working drawings. The performance of the various types of switches is given in the form of tables and graphs.—*Gratis to interested parties*

214—THE AMAZING ELECTRON

A 33-page booklet published by the Electronic Corporation of America. It is illustrated in cartoons and drawings and explains to the layman, some of the miracles of modern electronics. Not a book for engineers but written primarily for the public at large.—*Gratis*

215—ALTEC SPEAKERS

An illustrated pamphlet on high-fidelity speakers, issued by The Altec Lansing Corporation. Complete with frequency response curves from zero to sixteen thousand cycles.—*Gratis*

216—INDUSTRIAL TRANSFORMERS

An illustrated catalog of industrial transformers is issued by Dongan Electric Manufacturing Company. Included

in the Dongan line are transformers for oil burners, fluorescent tubes, neon signs and motor control.—*Gratis to interested parties*

217—DIATHERMY TUBES

Taylor Tubes, Inc., has issued a folder cross-indexing the various types of diathermy machines and the tubes that are used. This is of interest to manufacturers and users of diathermy equipment.—*Gratis*

218—VIBRATOR GUIDE

The Mallory Replacement Vibrator Guide is issued by P. R. Mallory & Company. It is a complete listing of radio equipment using vibrator type power supplies and gives the number of the vibrator used as a replacement. Of interest to servicemen and radio supply retailers.—*Gratis*

219—SOUND ACCESSORIES

Atlas Sound Corporation has issued a catalog, F-41 that lists many pieces of sound accessories. This illustrated catalog lists speakers, baffles, enclosures, microphone stands, and similar apparatus.—*Gratis*

220—CERAMIC CAPACITORS

The Electrical Reactance Corporation has issued two pamphlets describing two new types of ceramic condensers that they have developed. These condensers have solid silver electrodes. Type CN has parallel leads and type CI has axial leads.—*Gratis*

221—COMMERCIAL TRANSMITTER

A four-page pamphlet has been issued by Aireon. It illustrates a 50-watt complete ground station for airline and other commercial applications requiring low-power transmitters.—*Gratis*

222—ALNICO MAGNETS

An eight-page pamphlet issued by Arnold Engineering Company. It gives engineering data on Alnico permanent magnets in the form of tables and graphs. Of interest to manufacturers.—*Gratis*

223—CAPACITOR REFERENCE GUIDE

The Magnavox Company issues a 20-page reference manual on electrolytic condensers. Illustrated, with each type of condenser described with working drawings. This manual is particularly interesting to manufacturers and distributors.—*Gratis*

COMMUNICATIONS

SERVICEMEN'S CORRESPONDENCE—AN EXAMPLE

The editor of Radio Craft

I have read the editorial in the November issue as well as the comment in the February issue by Mr. Rubane, on the subject of a good typewriter and a neat letterhead. I ask you now, what is wrong with the paper that I write this on, and what is wrong with the whole thing? I'll tell you. According to your way of thinking, the paper does not have the neat letterhead which you prescribe and I do not happen to have the nice new typewriter recommended personally by you, and I also know that the form is not as good as it should be. You see, this is Sunday and my secretary does not work today so I have to do all this alone.

I am one of the fellows that was forced to sell out when my draft board called and since I have returned I have found the same trouble as the two other fellows who have written to you. Mr. Rubane hit the nail on the head when he said that the veterans are the poor slob that went out to win the war while the Draft DODGERS stayed home and ate up the post-war gravy. I had a good business before the war and now what do I come home to. Well, that is not my worry because I am making a living. The thing I don't like about this thing is that we are not given the chance that we should have. We could not help it if we were away from home while all the post-war planning and agencies were being given out. All we were doing was the fighting so those big shots who got the agencies could use them. Now that we have won these rights for the plutocrats, they tell us to go jump in the lake. I would have an outlet for some good equipment if the Manufacturers and Distributors would have saved a spot for the proper Distribution in place of thinking of the extra dollar he might get by handing it to the highest bidder. I say, Mr. Editor, it is time for you to change your mind and get behind the veteran and push. (I don't mean over the cliff like you have done in the past)

A man in your standing should have sense enough to know where his bread and butter comes from. You wouldn't have your nice cozy home and a nice polished desk in your office if we, the veterans, had have laid down our arms on the battle field and said, we are going home and get some of those post-war ideas before the plutocrats get them. We wouldn't have got them ether because the Japs and Germans would have got here ahead of us. Why don't you and some of the other big boys in your line help us to get some of the better deals that are available at this time? I don't like to wave the flag

but I think it is high time that some of you and your kind got wise to who made it possible for you to stay in business and preserved your freedom so you could live your own life. This would have been a hell of a place to live if Hitler or the Japs had have gained control of our country and YOU, Mr. Editor, Know it. Now, let's see you get busy and help some of the fellows that helped you.

JACK R. MASSEY.

(Perhaps it would have been better had we reproduced Mr. Massey's letter photographically. Unfortunately, this would have taken over a page in Radio-Craft, and our readers appreciate that this would not have served any purpose. Instead, we reproduce the letter, complete, with its faulty English, and its bad spelling, exactly as it was received.

Mr. Massey speaks of a "letterhead." The letter was written on an excellent bond paper—two blank sheets of paper—but not a printed letterhead. The only good thing about the letter is the paper. It is as if Mr. Massey had put on his best suit—minus the pants—and called on a radio manufacturer.

Everything we said editorially in our November issue was violated in this letter. For instance, the typewriter was so battered that the letter "a" is out of alignment, making it most difficult to read the letter. For \$5.00 the typewriter could be put into shape so that the recipient of a letter would at least be able to read it without irritation.

We repeated verbatim what we said in our November issue, to wit:

"If we cannot typewrite ourselves, we would get somebody in our community to do the work for us, because if we have a beautiful letterhead, yet have our letters typed by an amateur, *this is worse than not having a letterhead at all.*"

To put it in another way, you can "hire" English the same as any other commodity. A good high-school girl would be glad to write letters for a small sum per letter and would actually be gaining experience helpful to her in a business course. There is no more justification for poor composition or English than for poor paper.

Mr. Massey does not seem to have learned that in this world we must conform to many things. When he was in the Army he was taught a rigorous routine, particularly that of order and neatness. His buttons had to be shined; so had his shoes. *Appearance counted for a lot.* Yet, in the civilian world, where exactly parallel conditions prevail, our correspondent wants to have

(Continued on following page)

"TAB"

SPECIAL BUY

(Limited Quantity)

Crystal Diode Sylvania IN21 Sil. C. three for	\$1.00
Crystal Diode holder cartridge type three for	1.00
Einac or H.R. VT127A & connectors, new Govt. 1.	4.95
G.E. Neon 1/4 W. NE16/891 (LP 42c) four for	1.00
RCA GAC7-1852 new govt. insp. (L.P.\$1.75)	.85
Cathode Ray Tube new govt. insp. 5AP1 (LP\$20)	9.95
Cathode Ray Tube new govt. insp. 5BP1 (LP\$20)	9.95
Cathode Ray Tube new govt. insp. 5BP4 (LP\$27)	9.95
Rectifier 872 new govt. insp. (LP\$7.50)	4.50
Circuit Breaker Heineman 3 or 20 amps 110V.	.97
Circuit Breaker Heineman .010amp 2300V. DC	.97
G.E. Switchette CR1070C103F3 DPNOC Ave for	1.00
Micro-Switch leaf type 10A. 125V. SPNO 3 for	1.25
Relay Sigma sens. 5AH 200 ohm 3.5ma SPDT	2.25
Relay W.E. sens. 3500 ohm SPDT 5A contacts	.97
Relay 105 Ward L. 115V 60cy SPDT 20A ets	1.90
Micro wave ant. with coaxial enter & mtr. brkt.	.95
FM Television Rotatable UHF Coupler	3.85
Co-Axial 52.72 ohm RG8&11U cable 100ft. for	12.00
Lacing Cord Mildew Resistant #8 treated lb.	1.90
Thermostat operates 85 deg F. 15amp three for	1.90
G.E. DW44 R.F. Thermomtr 0-1A. 2 1/2" B' case	3.95
G.E. DW52 R.F. Thermomtr 0-5A. 2 1/2" B' case	3.50
AC Voltmeter NA33 Watghse. 150V60cy 2 1/2" B'o	2.95
DC Voltmtr 2000V. prec.mult. 1000/V. 2 1/2" B'o	8.95
DC Voltmtr 4000V. prec.mult. 1000/V. 3" B'o	10.95
DC Voltmtr 10,000V. prec.mult. 1000/V. 3" B'o	12.95
Resistor Presis. N.I. Sprague 10 meg (LP\$90)	3.00
R.E.S. prels. N. W.E. Hermetically sealed 1/2	4.45
1000. 5000. 10000. 30000 each 25c. 80000 ohm	65
100000. 200000 ohm each 55c. 500000 ohm	65
Resistors 100000 1/2 & 1 W BT 50 to 2 meg.	2.50
Hammarlund socket UHS 900X Acorn (LP\$1.50)	.30
Amphenol high V. safety socket 77A-4T Two for	.73
Johnson #247 socket for 829 tube statelite ins.	.85
Socket octal amphenol 78-58T-HF ins. 25 for	1.49
Johnson 50 w. socket hvy duty type H.F. Statelite	.85
Johnson miniature 277 B socket & shield HF ins	.25
Daven S.C. switch 13 cts. H.F. ins. 25 amp ets.	.49
Radio Noise Filter Mallory NF1-7 oil cond	.48
Transformer 6400V.C.T. A Kenyon 115V60cy	18.90
\$1 Min. orders FDB. N.Y.C. Add Postage all orders	
and 25% deposit. Whitehall 3-3557. Send for catalog	
300. Don't wait, rush orders are quantities are limited.	
Choke G.E. Wheeler 4 hy. 1/2 A. 30 ohm wt.	2.95
New Vacuum Tube Voltmeter S.C. 1-107-F	29.70
Condenser GE 1MFD-1000V. @ 60c. ten for	5.00
Condenser GE pyranol 3MFD 330V AC 1000VDC	.95
Condenser Solar 25M MF 10000 V. RF (LP\$21)	.95
New Bendix auto'srvt. govt. insp. 110V60cy pair	18.00
Aircraft owner Impd. Jefferson 100 Hy 3100 ohms	.89
Ohmite 25 w. 250 or 350 ohm (LP\$4)	1.45
Millen 36001 ceramic plate cap 9/16 & 3/4" 6 for	.90

"TAB," Dept. RC5
6A Church Street, New York 6, N. Y.
Our Central Location

ELECTRICIANS! RADIO MEN!

Earn More Money!

Get this new
GIANT SIZE



**ELECTRICAL
and RADIO
TROUBLE
SHOOTING
MANUAL**
GUARANTEED BY
COYNE

Yours 10 Days Free!

**OVER
500
Large Size
Electrical
and Radio
Shop Prints
-How to read
and use them**

Needed by was workers, maintenance men, beginners, old timers! Nothing else like it. Saves time, helps boost your pay... 4 GREAT BOOKS IN ONE! 1. New Step-by-Step Trouble Shooting Course. 2. 500 Shop Prints. 3. Elec. Radio Dictionary. 4. Spare Time Jobs. **FREE!** 1 yr. Technical Counsel by mail from COYNE staff, on trouble-shooting problems.

SEND NO MONEY! See offer below. Satisfaction guaranteed by famous COYNE "Learn-by-Doing" Electrical School. Rush coupon now!

FREE TRIAL COUPON

Mr. C. LEWIS, President, Dept. 66-K7
COYNE ELECTRICAL SCHOOL
500 S. Pauline St., Chicago 12, Ill.

Send, with all shipping charges paid, your new COYNE Electrical and Radio Troubleshooting Manual. Within 10 days after receiving it, either return it or send \$3. (If you do not wish to pay total of \$9.95 is paid.) Cash price \$8.95 - you save over 10%! Same 10-day free trial and return privilege.

NAME _____
ADDRESS _____
CITY _____ STATE _____

BUILD YOUR OWN FAST FREEZER

It's easy to build this household appliance and profitable to use. Save up to 75%. Operates on 110 or 32 volts. Plans show 5 sizes and are easy to follow. **ENJOY MAKING ONE OF these freezers from new or used parts. No expert knowledge needed. Mail \$1.00 bill or check for complete plans and catalog.**

5 sizes
8 to 40 cu. ft.

LE JAY MFG. CO., 456 Levy Bldg., Minneapolis 8, Minn.



SPECIAL Introductory Offer
10c per Pack, 12 for \$1.00 Postpaid
RADIO HARDWARE

Machine Screws			
Cat. No.	Size	Quantity	Cat. No.
501	4-36 x 1/4	16	508
502	4-36 x 1/2	16	509
503	4-36 x 3/4	13	510
504	6-32 x 1/2	15	511
505	6-32 x 3/4	14	512
506	6-32 x 1	12	513
507	6-32 x 1 1/4	8	514
Self Tapping Screws			
515	4 x 1/2	8	518
516	4 x 3/4	8	519
517	6 x 3/8	8	520
Metal Washers			
521	For No. 6	25	523
522	For No. 8	25	For No. 10
Hexagon Nuts			
524	4-36 x 1/4	16	526
525	6-32 x 5/16	15	527
Lockwashers			
528	For No. 6	15	530
529	For No. 8	15	531
Assortments			
532	Wood Screws	10	
533	Grommets	4	
534	Cable Clamps	6	
535	Dial Springs	2	
536	Spade Bolts	7	
537	Set Screws	5	
538	Fibre Washers	15	
539	Soldering Lugs	15	
540	Rivets	15	
541	Mounting Nuts	4	
542	Grid Caps	4	

We Can Supply All Types of Radio Hardware
WRITE FOR OUR COMPLETE CATALOGS
DEALERS Write for complete
JOBBERS catalogs and discounts
TRUTONE PRODUCTS CO.
303 W. 42nd St., New York 18, N. Y.

ATTENTION!
Introducing Our
First Post-War
**MULTI-TESTER
KIT**

Ideal for Use By
Students • Schools
Hospitals • Amateurs
and Servicemen.

5 voltage ranges, 3
current ranges, 3
ohm ranges.

Volt Ranges: 0-5-
50-150-500-1500 volts. Current Ranges: 0-50-150-500
Ma. Ohm Ranges: 0-2000-20,000-200,000 ohms.

Model 120 (Illustrated) **\$9.95**
Complete Kit @

In addition our previous models of meters and Radio
Kits are still available.

Radio Kit model S-5, complete with tubes @ \$19.95
Radio Kit model TRF-4A, less cabinet @ 10.95
Radio Kit model S-6, less cabinet @ 17.95
25% Deposit on C.O.D. Orders. Write for Free Catalog.
We carry a complete stock of parts.
Export Inquiries Invited.

RADIO KITS COMPANY

Dept. M 120 Cedar St. New York 6, N. Y.

HAZELTON INSTRUMENT CO.
Electric Meter Laboratory

Electrical instruments, Tube Checkers,
and Analyzers repaired.

140 Liberty St., New York, N. Y.
Tel. BRarclay 7-4239

CRABREE'S
WHOLESALE RADIO

2608 Ross Ave.

DALLAS 1 TEXAS

COMMUNICATIONS

(Continued from previous page)

everything his own way instead of trying to conform with custom and usage.

Radio-Craft is happy to note that Mr. Massey is making a living, but he certainly could double or triple it, if he would conform to present day business rules, which unfortunately he seems to have no inclination to do.

"God helps them that help themselves." An old and true saying, which is particularly apt today.

We are positive that Mr. Massey—as well as other ex-servicemen—can get outlets from radio manufacturers and distributors **IF ONLY HE WILL SHOW THEM THAT HE IS DESERVING.** Rest assured that we speak authoritatively when we say with emphasis that *deserving* ex-servicemen are giving places these days.

THERE HAS NEVER BEEN SUCH A SHORTAGE OF GOOD OUTLETS FOR RADIO MANUFACTURERS AS THERE IS AT PRESENT.

"RADIO-CRAFT" IN OCCUPIED TERRITORY

Dear Editor:

I feel I must write and thank you for *Radio-Craft*.

Early in the German occupation of Guernsey I was lucky enough to come across a few copies of your magazine, which I regret I had never before known. I soon remedied that after the war. Now I receive my issue every month, though usually three months late.

As you are aware, radio was banned by the Germans and all work had to be done under very difficult conditions, but by various means we still listened to the news. We finished up with crystal receivers, making them from all sorts of materials; the crystals from a mixture of lead and sulphur or galena crystallized in a pipe cap after heat-

ing. Telephone receivers were rewound with wire taken from audio transformers to increase the resistance.

Reception was very good from the A.E.F. transmitter in England about 100 miles away; in some instances at loud speaker strength; hardly believable, but proved many times.

Your magazine was one of my best friends during those five years. I read, re-read, and then read them again; the articles always seeming to bring out some point I had not noticed before. I regret that some of the articles in recent issues are rather too technical for me at present, but I hope to catch up soon.

To quote the old proverb: You can lead a horse to the water, but you cannot make him drink.—*Editor*)

H. CAPPER,
Guernsey, Channel Islands.

A FEW COMPLIMENTS AND CRITICISMS

Dear Editor:

I have quietly said nothing and received each issue of *Radio-Craft* in the mail without voicing my opinions of your magazine. As with all magazines, there are good points and bad points. Human nature demands that your readers tell you only the bad points about your publication and none of the good.

Your January issue and the February issue look promising with those articles written by your Editorial Associate Mr. I. Queen. *Don't* lose him! And let's have more like him! Your features such as "Radio-Electronic Circuits," "Try This One," and "The Question Box" are very good. Keep them going!

How about a feature called "Experimenting on the Ultra-High Frequencies?" Use circuits that the home radio-man, experimenter, and amateur radio operators can use. Leave out this stuff about magnetrons, etc. There is still a

lot that the old tubes can do.

How about articles on complete medium-power transmitters for the ultra-high amateur bands? How about a series on test equipment that can be built by the home radioman and used in the radio shack? Why not advertise for writers?

I don't want you to think that I am a "know-it-all." Why not ask your readers what they want. Print some of my letter in your "Communications" column and ask for comments. If the old *Short Wave Craft* readers have fallen back on *Radio-Craft* for radio reading—you'll hear from them. I remain, a radioman who cries for the good old days.

SHERIDAN B. LAPORTE
Worcester, Mass.

(Mr. LaPorte will doubtless be pleased to see in this issue the first of a series of practical constructional articles on high-frequency transmitters and receivers by I. Queen.—*Editor*)

A U.H.F. HAM TRANSCEIVER

(Continued from page 545)

to feel the effects of the u.h.f. These can be shown by the following table:

PLATE VOLTAGE	LOW FREQ		HIGH FREQ	
	I_p	I_g	I_p	I_g
100V	.25 ma	490 μ A	2.5ma	110 μ A
220V	1.5 "	850 "	4.0 "	250 "

Effect of frequency change on I_p and I_g .

These unloaded circuit values show the higher efficiency obtained at the lower end of the range.

For greater output it may be desirable to work on the lower portion of the amateur band (even when the remainder opens up) if conditions permit. Our tuning arrangement is ideal in this respect since it permits very good band spreading in this region. More than a fourth of the dial rotation covers the present third of the amateur band.

The antenna consists of a $\frac{1}{4}$ -inch aluminum tube about 5 inches long within which a 3/16-inch piece of tubing slides. This means that the total length can be extended to almost 10 inches. A quarter wave-length is about $6\frac{1}{4}$ inches at 425 mc but the antenna should be experimented with for best results at any frequency. Coupling is provided by a half-turn of No. 16 wire. If a relatively great distance is to be covered it is recommended that another quarter wave-length be added on the other side of the loop, making a dipole. Better yet, an array of directional radiators should greatly increase the range in any given direction, but on the other hand, will take the transceiver a little out of the portable and convenient-to-handle category.

A phone tip at one end of the antenna (held by means of a screw through the tubing) fits into a tip jack and makes the radiator removable when the transceiver is not in use or being carried about.

AUDIO SECTION

The choice of modulator (and audio amplifier) also fell upon the 955 tube, but for different reasons. Here we were concerned with size and power requirements, as well as the fact that two tubes of the same type make for simple testing of tubes and permits putting the best one in the oscillator section. These tubes are not generally tested at the

time of purchase and we can only hope for the best. It happened in this case that one was slightly better than the other as an oscillator on the high frequencies. There is no apparent difference in efficiency in the audio stage.

MICROPHONE CIRCUIT

The circuit is conventional among transceivers. We used a Stancor A-4413 microphone and audio transformer. This is the largest component in the unit, but its cost is reasonable and it eliminated time and effort that would be spent in adding windings to a straight audio transformer, as is sometimes done. Since the purchased unit matches a 200-ohm microphone and a 10,000-ohm plate to a single grid input the amplifier gives very good results. The output is ample to run a 2- or 3-inch PM speaker and with phones the signals are really loud! The primary of the speaker transformer (or headphones) acts as the modulation choke.

A carbon mike with two pen-light cells is found to give sufficient modulation. There is plenty of room to add another should the output of any particular mike be found to be low, but 3 volts is ample here. The mike jack is designed to short out the microphone winding when the unit is used as a receiver with no mike plugged in. Otherwise there is a terrific hum due to the open winding. Plugging in puts the battery in series with the winding. If the mike has a "press-to-talk" switch it (the mike) need not be removed even when a long period of transmission is scheduled. The circuit appears in Fig. 1.

We don't find it necessary to include another switch to open the speaker secondary in order to avoid feedback to the mike. If the two are separated by a few feet and if they don't face each other this will not cause trouble. If necessary, however, the switch may be placed right on the speaker and need only be a single-pole single-throw type.

POWER SUPPLY

It was found desirable to design a small power supply which would deliver sufficient voltage to run the transceiver during the tests. The size of power transformer we would have liked to use and those available didn't coincide, so we went over to the voltage-doubler a.c.-operated idea. A 117Z6-GT tube (which now seems generally available) is used in the supply.

Relatively small condensers are used across the tube elements and a large (capacitance) value across the d.c. output. This eliminates some of the disadvantages of high capacitance

(Continued on following page)

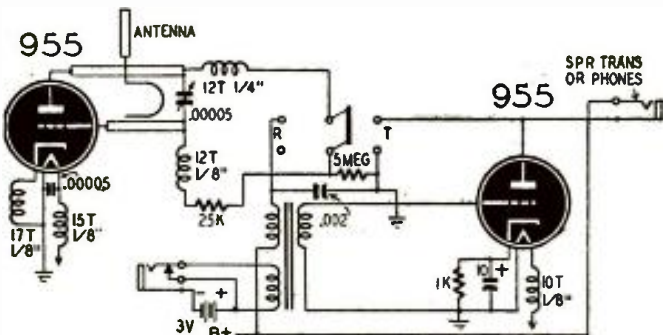

Fig. 1—Schematic diagram of the 420-450 megacycle transceiver.

There's a new kind of AMPLIFIER

a-coming!

and A. C. Shaney
is "a-fixin' to build it"
at Amplifier Co. of America

Technicians want a better kind of amplifier . . . and they are going to get it! For there is an amplifier in the making at Amplifier Co. of America today, that promises to revolutionize the industry's thinking about the amplifier of the future. It is cleverly designed, beautifully constructed and most amazing in its performance. Its fundamental design is one of the truly exciting secrets of our time. New circuits, new materials, and new processes combine in this amplifier to achieve a triumph of modern engineering.

It may not be the first amplifier off the line, but it may well be the first completely new one. And amplifier men know that A. C. Shaney and his associates at Amplifier Co. of America have what it takes to build the kind of an amplifier that engineers, technicians and music lovers are waiting for.

That's why so many thousands today are "watching the news" from

AMPLIFIER CO.

of **AMERICA**

398 BROADWAY, NEW YORK 13, N. Y.

A postal card will put you on our mailing list to be among the first to know.

18 YEARS IN RADIO

GET THIS
New CATALOG
By This Old Firm



Latest developments in radio and electronic parts and devices, newest ham gear, gadgets for experimenters, bargains in war surplus items.

FREE TO YOU

Mail the coupon below and get this new catalog FREE.

BURSTEIN-APPLEBEE CO.,
1012 McGee, Kansas City 6, Mo.

Send me FREE catalog advertised in
Radio Craft

I AM _____
STATE CONNECTION IN INDUSTRY _____
NAME _____
ADDRESS _____
TOWN _____ STATE _____

ATTENTION

Radio Servicemen and Appliance Dealers
Send for our latest catalogue sheets.
Many hard-to-get items.

John A. Cox Radio Supplies

55+ Seventh St.

Parkersburg, W. Va.

LAKE'S RADIO Cabinets & Parts



NOW Available
Postwar 2 Post RECORD-CHANGER

In luxurious brown leatherette portable case 15" L x 15" W x 10" D. Latest electronic developments make this modern record-changer the finest on the market today!

List Price . . . \$49.95 Dealer's net . . . \$29.97

Also blank table cabinets of walnut veneer in the following sizes, with speaker opening on left front side. (Note: 7" has center speaker grill.)

#1	8 1/4"	L x	3 1/2"	H x	4"	D	\$1.95
#2	10 1/4"	L x	6 3/4"	H x	5"	D	\$2.75
#3	13 1/2"	L x	7 5/8"	H x	6 1/4"	D	\$3.25
#7	10 3/4"	L x	7"	H x	5 1/2"	D	\$2.50

*Speaker Opening in center of front side.

All types of radio cabinets and parts are available at Lake's lower prices. A large stock is listed in our catalog.

SERVICEMEN-RETAILERS
Join our customer list today.
Write for our NEW, 12 page, illus. treated, elaborate catalog Order from Lake! You'll make no mistake!
Dept. C



LAKE RADIO SALES CO.

615 W. Randolph Street, Chicago 6, Ill.

RHS SPECIALS

WESTON METERS:

0-5 MA—Mod 301	\$4.95
0-100 MA—Mod 301	4.95
0-1 Amp—Mod 301	4.95
0-150 V. A.C.—Mod 476	4.95

RG 58/U Coax.08
RG 11/U Coax.10

RG 58/U Per foot **\$.05**

COIL SET: will tune to 2 through 30 megacycles with 235 mmfd condenser. Consists of 4 stages: 2 RF, 1 mixer, 1 oscillator, 4 coils in each stage. 20 coils in all, with 18 air trimmers, permeability slugs in each coil, 4 wafer ceramic bandswitch. Wired and mounted on four separate shielding plates . . . ready to put into set and connect. With Diagram:

Set \$10.00

1/3 with order

RADIO HAM SHACK

63 Dey St., New York 7, N. Y.

Send for our Catalog of TOOLS & EQUIPMENT for DEVELOPMENT WORK WATCHMAKERS TOOLS

CATALOGUE

of Precision Tools, Equipment for Development Work, for the making of New Worlds. State your business when ordering catalog.

37 South Wabash Ave.
HENRY PAULSON & CO. CHICAGO U.S.A.

In the Rocky Mountain Region it's RADIO & TELEVISION SUPPLY CO.

150 Hubson Ave., P.O. Box 892
PUEBLO, COLO.

"If we don't have it, we'll get it—
or it can't be had! Phone 5729"

TO OUR SUBSCRIBERS

We are sorry that RADIO-CRAFT has not been reaching you on time lately. This has been due largely to the difficulty in obtaining paper. Hundreds of other publications are similarly affected. Fortunately conditions are rapidly improving. Effective with the next issue we hope to resume our normal mailing schedule.

INDEX TO ADVERTISERS

Adson Co.	567
Aerovox Corp.	562
Allied Radio Corp.	549
Amperite Co.	577
Amplifier Co. of America	585
Arrow Electronics	569
Audel & Co., Theo.	556
Bell Telephone Labs.	526
Buffalo Radio Supply	582
Burstein-Applebee Co.	585
Cannon Co., C. F.	567
Capitol Radio Eng. Institute	528
Cleveland Inst. of Radio Elec.	559, 575
Concord Radio Corporation	523
Cornell-Dubilier Elec. Corp.	
Back Cover	
Cox Radio	585
Coyne Electrical School	583
Crabtree Wholesale Radio	584
DeForest's Training, Inc.	525
Electronics Service & Supply Co.	570
Free Want Ad Service	576
General Cement Mfg. Co.	581
General Electric Co.	572
Harrison Radio Co.	567
Hazelton Instrument Co.	584
Hudson Specialties Co.	578
International Resistance Co.	518
J. F. D. Manufacturing Co.	570
Kwikheat Div., Sound Equip. Corp.	571
Lake Radio Sales Co.	586
Leeds Radio Co.	580
LeJay Mfg. Co.	583
Liberty Sales Co. Inside Back Cover	
McElroy, T. R.	582
McGraw-Hill Co.	587
McMurdo Silver Corp.	557
Maedel Publishing House	587
Maritime Switchboard	579
Metropolitan Elec. Inst. Co.	561
Murray Hill Books	550, 551
National Radio Distributors	581
National Radio Institute	517
National Schools	527
National Union Radio Corp.	553
Newark Electric Co., Inc.	567
Ohmite Mfg. Co. Inside Front Cover	

Olson Radio Warehouse	573
Onan & Sons, D. W.	575
Opportunity Adlets	563
Pa-kette Radio Co.	581
Paulson Co.	586

RADIO SCHOOL DIRECTORY

Page 588

- American Radio Institute
- Candler System
- Cleveland Inst. of Radio Electronics
- Commercial Radio Institute
- Lincoln Engineering School
- Melville Radio School
- RCA Institutes, Inc.
- Tri-State College
- Western Radio Institute
- YMCA

Radio Corp. of America	555
Radio Electric Service	577
Radio Ham Shack	586
Radio Kits Co.	584
Radio Product Sales Co.	574
Radio & Television Supply Co.	586
Radio Wire Television, Inc.	568
Radolek Co.	573
Raytheon Mfg. Co.	520
Rosicrucians	580
Scenic Radio & Electronics Co.	577
Solar Capacitor Sales Corp.	581
Sprague Products Co.	524
Sprayberry Academy of Radio	521
Sun Radio Corp.	571
Superior Instruments Co.	519
Supreme Inst. Co.	566
Supreme Publications	565
"Tab"	583
Taybern Equipment Co.	581
Technical Apparatus Builders	583
Terminal Radio	574
Triplett Elec. Instrument Co.	563
Trutone Products Co.	584
Turner Mfg. Co.	554
Ungar Electric Tools, Inc.	564
Western Radio Institute	573
World Radio Laboratories	560
X. L. Radio Labs.	582

A U.H.F. HAM TRANSCEIVER

(Continued from previous page)

input power supplies such as poor regulation, severe load on tube, etc. A small choke was included to help smooth ripple. Hum is inaudible on the speaker. Using headphones there is a slight hum, as might be expected, but when the transceiver is oscillating or super-regenerating it is very low and is lost in the "rush."

The output of the supply can be varied from zero (useful when making tests within the set or changing tubes, etc.) to a full 225 volts at maximum drain of 13 ma. A voltage control is always desirable in connection with super-regenerating receivers and is a good thing when testing the transmitter at different inputs. It will be noted that the voltage must be progressively increased for satisfactory results as the 500 mc point is approached, otherwise the super-regeneration drops out leaving only ordinary oscillation and a very insensitive condition. (See Fig. 2.)

The operation of super-regenerative

receivers and of Lecher wire frequency checks has been covered recently (in the January and February issues). The

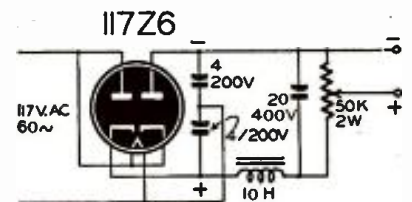

Fig. 2—The variable-voltage power supply.

same principles apply to these higher frequencies. The frequency calibration of receiver and transmitter must be made to a closer tolerance as far as actual dimensions are concerned. In other words, a fraction of an inch difference means more frequency deviation above 400 mc than it does below 150. It will be found that the Lecher measurement will show a sharper indi-

(Continued on page 588)

BOOK REVIEWS

ELECTRONIC EQUIPMENT AND ACCESSORIES, by R. C. Walker. Published by Chemical Publishing Company. Stiff covers, 5½ x 8¼ inches, 392 pages.

This book, prepared principally for engineers and students, presents in interesting detail the fundamentals of operation of many types of electronic equipment and their accessories.

The first five chapters deal with the more conventional types of vacuum tubes and their applications to metering in industry.

Chapters six through eleven cover light-sensitive and light-producing devices, their fundamentals and uses in commercial practice. Cathode ray tubes, photo cells and sources of light are included. Interesting applications of the neon glow tube as a voltage regulator is found in chapter eleven.

Mechanical and electronic control devices are covered in chapters twelve and thirteen. The portion on mechanical switching is very complete. Working diagrams of thermal delay, vacuum delay and mechanical delay switches are illustrated.

The closing chapter discusses, briefly, many of the fundamentals and applications not covered elsewhere in the book. This includes small a.c. and d.c. motors, metallic rectifiers and regulators.

A thirteen-page appendix of various mathematical formulae and relationships is a useful addition to this book.

PRINCIPLES OF RADIO FOR THE OPERATOR, by Ralph Atherton. Published by The Macmillan Company. Stiff cloth covers, 5½ x 8¼ inches, 344 pages. Price \$3.75.

A simplified volume on radio theory, this easily-read book is an excellent text for students. Freedom from mathematical phraseology, other than the simplest algebra, will make it easily understood by the non-technical reader.

It is well illustrated with over five hundred drawings and photographs.

The first three chapters are devoted to the nature of electricity and the various methods of generating it. Ohm's Law is covered very well in this section. The next three chapters are on magnetism and its application to motors, generators and meters.

The last ten chapters are devoted purely to radio theory. Each component of the set is explained in a surprisingly thorough manner for a text of this nature. As each part is explained, it is illustrated both photographically and diagrammatically, the symbol for the component being learned at the same time.

Teachers of beginners in radio theory will find advantageous the visual training aids recommended at the end of each chapter.

TWO-WAY RADIO by Samuel Freedman, Commander USNR. Published by the Ziff-Davis Publishing Company. Stiff cloth covers, 6 x 8½ inches. Price \$5.00.

This is possibly the most comprehensive text ever written about two-way radio. It covers this entire field from fixed and mobile units to marine and aeronautical applications.

Low-frequency long-wave applications receive the same treatment as FM and u.h.f. installations and theory. It is rather surprising, however, to find interspersed amongst wave guides and cavity resonators, basic reviews of Ohm's law and elementary a.c. theory. For example, the author speaks of "functional comparisons of v.h.f. versus microwaves," "beamed transmissions" and trapping as related to atmospheric densities," then breaks off and presents the formulae for capacitive and inductive reactance, followed by a somewhat lengthy dissertation on LC ratios and Q.

Some of the chapters, such as those on two-way railroad radio, personalized and private applications (citizen's radio), police, fire, and forestry services, and maintenance and repair of transmitters and receivers, are more than sufficiently interesting to offset these minor digressions.

The nineteenth chapter, on licenses and regulations, comprises a summary of the relevant parts of the Communications Act and new applications and amendments as they apply to individual, private firm or corporation, and public utility or semi-official use of two-way radio. The entire volume is interestingly illustrated and diagrammed throughout and, except for minor inaccuracies, such as reference to the Civil Air Patrol as "Civilian Air Patrol," appears to be accurately compiled.

TELEVISION SHOW BUSINESS by Judy Dupuy. Published by General Electric Company. Size 8½ x 11 inches, soft paper covers, 246 pages. Price \$2.50.

Probably the first actual television production text book to be offered to the general public is this manual by Miss Judy Dupuy. It is strictly, as the title implies, a non-technical manual, though the reader will unconsciously pick up a certain amount of technical lingo along with the material on "How to become a television director or producer in 36 easy lessons."

Some of the more interesting chapters on telecasting cover variety shows and revues, drama, television commercials, studio and control room procedure, and hints and tips for the television actor. The scripting requirements are covered rather thoroughly. An up-to-date glossary of television terms and slangage (dictionary style) completes lesson 37. Do's and don'ts summarized at the end

(Continued on following page)

Now-142

important design articles
on ELECTRONIC equipment
and parts . . .

This handy reference book brings to designers, builders and users of electronic equipment and parts a host of valuable aids—material which has been condensed into graphs, charts, and concise articles, to supply you with a short cut to more and better reference data in your field. It contains a multitude of engineering aids related to the design of circuits, equipment and individual parts for radio, electronics, television, facsimile, radar, sound, and related vacuum-tube apparatus—including topics brought into prominence by acceleration of wartime electronic research.

Just Published ELECTRONICS for ENGINEERS

Edited by JOHN MARKUS and VIN ZELUFF
Associate Editors, Electronics

390 pages, 8½ x 11, figures, \$6.00

This rich source of data contains over a hundred different articles, each one a "find" for the electronics man who needs concise, easily available information to aid him in his work. It represents design articles, charts, and graphs selected from the complete files of Electronics magazine for their value to you, carefully condensed, edited, and indexed, and arranged in easily accessible form.

10 DAYS' FREE EXAMINATION SEND COUPON

McGraw-Hill Book Co., 330 W. 42 St., NYC 18
Send me Markus and Zeluff's Electronics for Engineers for 10 days' examination on approval. In 10 days I will send \$6.00, plus few cents postage, or return book postpaid. (Postage paid on cash orders.)

Name

Address

City and State

Company

Position

For Canadian prices, write: Embassy Book Co.,
12 Richmond St. E., Toronto 1

MATHEMATICS FOR RADIO

Two volumes, prepared for home study. Book I (314 pp.) covers the algebra, arithmetic, and geometry; Book II (329 pp.) covers the advanced algebra, trigonometry, and complex numbers necessary to read technical books and articles on radio.

MAEDEL PUBLISHING HOUSE Room 117
593 East 38 Street, Brooklyn, New York
Send me MATHEMATICS FOR RADIO AND COMMUNICATION as checked below. I enclose payment therefor with the understanding that I may return the book(s) within 5 days in good condition and my money will be refunded.

Name

Address

.....

Book I at \$3.75 plus 6c postage
 Book II at \$4.00 plus 6c postage
 Books I and II at \$7.75 postage prepaid

Foreign and Canadian prices 25c per volume higher

RADIO SCHOOL DIRECTORY

PREPARE NOW FOR SKILLED JOBS IN RADIO AND ELECTRONICS

MAKE a place for yourself in a new world of radio and electronics—a world in which revolutionary electronic developments will require highly specialized technical knowledge. Take a good course now to fit yourself for a good paying job. The training you need can be supplied by one of the schools advertised in this publication.



RADIO

Train with professionals. Complete, intensified courses; Repair & Maintenance, Communications, High-speed telegraphy, Slip transcription, FCC exams, etc.

High School Students accepted for training as Merchant Marine Radio Officers.

Gov't sponsorship available to veterans.

"A Radio School managed by radio men."
45 W. 45th St., Dept. RC, New York 19, N.Y.

MELVILLE RADIO INSTITUTE

RADIO COURSES

- RADIO OPERATING
- RADIO SERVICING — ELECTRONICS
- REFRIGERATION SERVICING

Personal Counselling Services for Veterans
Write for Latest Trade & Technical Catalog

Y.M.C.A. TRADE & TECHNICAL SCHOOLS
4 W. 54th Street New York City

RADIO

Home Study Courses for Radio Technicians and Radio Engineers. Prepare now for a better Radio-Electronics Job. Free Booklet. See our large ad. on pages 559, 575.

Cleveland Institute of Radio Electronics
RC-5 Terminal Tower Cleveland 13, Ohio



RCA INSTITUTES, Inc.

Offer thorough training courses in all technical phases of

Radio and Television

DAYS—EVENINGS WEEKLY RATES

VETERANS: RCA Institutes is approved under G. I. Bill of Rights
For Free Catalog Write Dept. RC-56

RCA INSTITUTES, Inc.
A Radio Corporation of America Service
75 VARICK STREET NEW YORK 13, N. Y.

LEARN RAPID RADIO SERVICING

Send for Free Information: "3 Ways to Learn Radio." Approved for Training Veterans.
(See our ad on page 573)

WESTERN RADIO INSTITUTE
1457 Glenarm, Denver 2, Colo.

SENDING SPEED

CODE RECEIVING

Be a "key" man. Learn how to send and receive messages in code by telegraph and radio. Commerce needs thousands of men for jobs. Good pay, adventure, interesting work. Learn at home quickly through famous Candler System. Write for FREE BOOK.

CANDLER SYSTEM CO.
Dept. 3-E, Box 928, Denver 1, Colo., U. S. A.

RADIO

RADIO Technician and Radio Communications courses. Register now for new classes starting first MONDAY of each month. Day and Evening Classes.

AMERICAN RADIO INSTITUTE
101 West 63rd St., New York 23, N. Y.
APPROVED UNDER GI BILL OF RIGHTS.

Correspondence Courses in RADIO and ELECTRICAL ENGINEERING

ELECTRICAL ENGINEERING Get good steady future. Prepare yourself, at Low Cost, for secure future. Modern, simplified, you can understand quickly.

RADIO ENGINEERING Get address, photo-electric work. Train you to be super-service man, real vacuum tube technician. Service men needed badly. Diploma on completion. Tuition \$25, either course. Deferred payment plan.

FREE magazines, complete details. SEND NOW!

LINCOLN ENGINEERING SCHOOL Box 931C-87 Lincoln, Nebr.

COMMERCIAL RADIO INSTITUTE

A radio training center for twenty-four years.

●

RESIDENT COURSES ONLY

Broadcast, Service, Aeronautical, Television and Marine telegraphy classes now forming. Literature upon request. Veteran training. Classes now forming for July 1st.

Dept. C, 38 West Biddle St., Baltimore 1, Md.

RADIO ENGINEERING!

DEGREE IN 27 MONTHS

VETERANS can complete work here in shortest possible time. Courses also in Civil, Electrical, Mechanical, Chemical, Aeronautical Engineering; Business Administration, Accounting, Secretarial Science. 63rd year. Enter June, Sept., Jan., Mar. School now filled to capacity. No applications can be accepted until further notice.

TRI-STATE COLLEGE 2456 College Ave. ANGOLA INDIANA

BOOK REVIEWS

(Continued from previous page)

of each chapter give the text a school-book flavor.

The continuity is excellent and very nearly meets the requirements of a perfect book: To make the reader forget he is reading and feel that he is actually living through each chapter with the author. Were it not for the superabundant presence of General Electric's television station call letters (WRGB) this manual would be 99 percent perfect. As it is, the slight marring of enjoyment by this repetitious redundancy is more than offset by the excellent photographs and entertaining story on the lesser-known phase of television; the story behind the "ike-lights."—*E.A.W.*

ELECTRONS IN ACTION, by James Stockley, General Electric Research Laboratory. Published by Whittlesey House, McGraw-Hill Book Company, Staff covers, 5½ by 8½ inches, 309 pages. Price \$3.00.

This book provides excellent material for study by the layman or student who desires a knowledge of the fundamentals of "everyday electronics." Fifty-four drawings, sketches and diagrams are used for graphic presentation of the subject matter. These are supplemented by forty-four well-chosen and well-reproduced photographs.

The operation of the magnetron and klystron oscillators is very well pre-

sented. The diagram of the klystron is particularly interesting and is seldom seen in this form.

Radio communication and television are discussed in the order of their chronological development. Some of the little-known men of science who nevertheless played important parts in the development of modern communication are mentioned.

Television is described from the earliest attempts to carry sight impulses over a wire or through the air to the present schemes of color television. To describe the modern methods of interlaced scanning, lines of the page are numbered in the same sequence as the scanning within the electron tube. It is possible to read the page only when the lines are scanned in the proper order.

A chapter discusses the effects of atomic and solar disturbances on transmission and reception of radio signals, and the final chapters deal with the relation between electrons and nuclear physics.

U.H.F. HAM TRANSCEIVER

(Continued from page 586)

coupling than at lower frequencies. The coupling should be adjusted so that the same reading will be obtained after several tries, within ¼ inch or better. Even this short interval represents about 1% of the frequency. The hand must not be kept too near the wires during the measurement. (Fig. 3 is the calibration curve.)

FREQUENCY

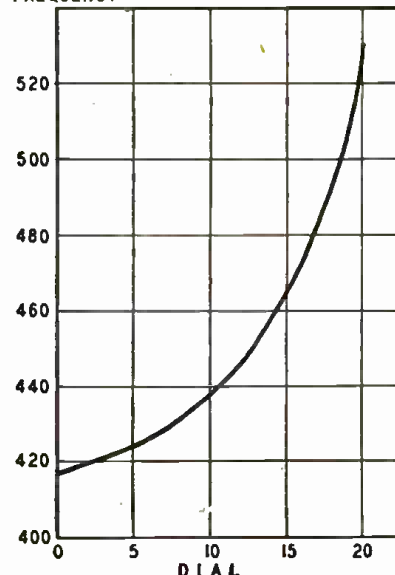

Fig. 3—Calibration curve of the transceiver.

The new amateur band offers an excellent chance to experiment with reflectors, polarization, etc. Thus, a sheet of aluminum placed behind an antenna will progressively and alternately increase and decrease the signal as it is moved steadily away from (or toward) it. Another rod or piece of tubing will act in the same manner. The latter may be held at its center by the hand as it is moved toward and away from the radiator. The effects of polarization are clearly shown in this way.

Liberty RADIO and PHONOGRAPH Kits...

6 Tube "Super Het" Radio Kit



COMPLETE, INCLUDING ATTRACTIVE WALNUT CABINET — Diagram Furnished
All Parts Mounted

To assemble, all one needs is a soldering iron and 30 minutes of your time.

Uses one 25L6—one 25Z6—one 6SQ7—one 6SK7—two 6SJ7's or one 50L6—one 35Z5—two 12SJ7's—one 12SQ7—one 12SK7.

YOUR COST **\$16.95** LESS TUBES

5 Tube "Super Het" Radio Kit

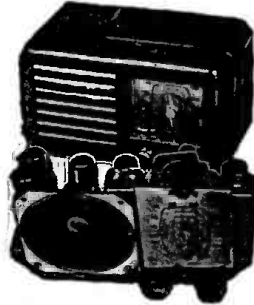

COMPLETE, INCLUDING ATTRACTIVE BROWN BAKELITE CABINET.

Diagram Furnished — All Parts Mounted APP SIZE 9x5x6 Inches

Uses one 25L6—one 25Z6—one 6SA7—one 6SQ7—one 6SK7 or one 50L6—one 35Z5—one 12SA7—one 12SQ7—one 12SK7.

YOUR COST **\$13.95** LESS TUBES

Portable Phonograph Kit

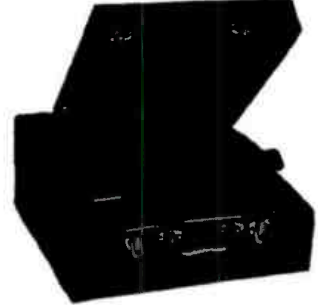

ATTRACTIVE COVERED CABINETS COMPLETE WITH MOTOR — PICK-UP — AMPLIFIER

SIZE: 14 x 7½ x 19

Uses one 25L6—one 25Z6—one 6CS.

YOUR COST **\$28.95** LESS TUBES

All the above Kits designed for simple construction

We carry a complete line of Radio Parts and Equipment—Contact us for "Hard to procure" items!!

IMMEDIATE DELIVERY

TERMS 10% Deposit with order. Balance C.O.D.

Special Buys for the Amateurs and Industrials

SPECIAL HIGH VOLTAGE MICA CONDENSERS

C.D. MICA CONDENSERS .02 — 600 V. WKGU D.C. TEST 1000 V. D.C. — Your Cost .12 cts.
C.D. MICA CONDENSERS .0004 — 2500 V. WKGU D.C. TEST 5000 V. D.C. — Your Cost .19 cts.
C.D. MICA CONDENSERS .0001 — 600 V. WKGU D.C. TEST 1000 V. D.C. — Your Cost .12 cts.

GENERAL ELECTRIC PYRANOL BASE MOUNTING — 1 MFD. — 500 Volts WKG. — Your Cost \$.65
GENERAL ELECTRIC 2.0 MU-F — 600 V. D.C. BASE MOUNTING. — Your Cost 1.10
SPRAGUE — 4 MFD — 600 V. D.C. OIL UPRIGHT: Size (2½ x 1¼ x 4) BASE MOUNTING. — Your Cost 1.59
CORNELL DUBILIER — 8 MFD — 500 V. WORKING UPRIGHT ALUMINUM CAN. — Your Cost .95
CORNELL DUBILIER OIL — 10 MFD — 600 V. D.C. BASE MOUNTING. — Your Cost 2.10
CORNELL DUBILIER — 15 + 15 MFD — 450 V. W. TUBULAR — Your Cost 1.10
AEROVOX OIL COND. IN CAN — .5 MFD — (Size: 1½ x 1 x ¾") — Your Cost .29
CORNELL DUBILIER OIL COND. IN CAN — 10 MFD 50 W.V. (Size 1¾ x ¾ x 1) — Your Cost .34
SWITCHES TOGGLE TYPE PUSH TO MAKE — Your Cost .14
SPECIAL CLOSE OUT G.E. METER MODEL 40ARB17 Reading 2.5—0—2.5 M.A.—
25—0—25 M.A. Two Readings — Your Cost 3.95

SPECIAL VOLUME CONTROLS — NO SWITCH
2½ INCH SHAFTS "STANDARD BRANDS"
1 meg — 200 M — 100 M — 500 M — 250 M — 60 M — 50 M
40 M — 20 M — 15 M — 10 M — 5 M. — Your Cost .25 cts. ea.
DUAL VOLUME CONTROLS — NO SWITCH
10 M + 5 M / 100 M + 100 M / 10 M + 75 M / 20 M +
20 M / 80 + 1000 — Your Cost .35 cts. ea.

"SPECIAL" — OIL BATHTUB CONDENSERS

ALUMINUM CAN
.05 MFD — 600 V. — Your Cost .08 cts.
3 x .05 MFD — 300 V. D.C. — Your Cost .19 cts.
1.2 MFD — 600 V. — Your Cost .14 cts.
3 x .22 MFD — 600 V. — Your Cost .39 cts.
15 MFD — 35 VOLTS WORKING — Your Cost .16 cts.

AN EXCEPTIONAL VALUE

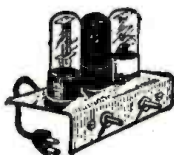

3 tube A.C. D.C. Phono Amplifier Kit—less tubes, with speaker—uses 6CS—25Z6—25L6—your cost

\$5.95

Record Changer

2 post complete with motor and pick-up. Fully Guaranteed. List \$37.50
YOUR COST \$22.50

INVERTERS

Converts D.C. Current to A.C. Cap. to 50 W.
YOUR COST \$10.75 EACH

IMMEDIATE DELIVERY

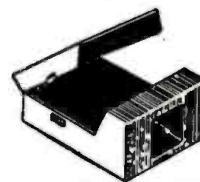

Portable Leatherette Cabinet for Electronic Phonograph. Your cost

\$7.75

Size 7 x 14½ x 18 inches

LIBERTY SALES CO., INC.

115 WEST BROADWAY
NEW YORK 13, N. Y.
BARCLAY 7-6063

Brother, want 3 extra hands?

Then drop a few seeds in the mailbox! C-D has them ready for you . . . punchy mailing pieces . . . to let the whole neighborhood know you're alive. And that's only one part of a complete promotional program we've prepared for you. Look around! The field is getting crowded; now is the time to promote yourself. And here is a program—complete—packaged—that'll give you three extra hands and make you "the" service shop in your community.

And watch the customers grow! You can't expect radios will break down faster to help your volume . . . but when they do get out of wack, you can bet the customers will take them to shops they've heard about. So get the ball rolling with the new C-D Sales Promotional Program that will help you grow—not only in 1946—but in 1947 and 1948.



USE THESE C-D HELPS AVAILABLE THROUGH YOUR LOCAL JOBBER!



NEWSPAPER MATS

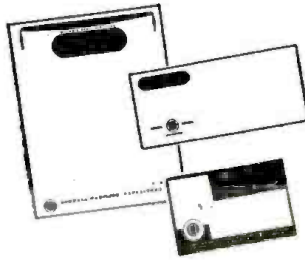

STATIONERY LABELS



DECALS



WINDOW CARDS



POSTCARDS — just address and drop in mailbox!



MATCH BOOKS —

KEEP YOUR REPUTATION GROWING WITH TOP QUALITY PARTS

C-D's "dwarf tigers" are long life units. Heat and humidity don't get them out of the picture. Real quality . . . real reputation-builders.

OF COURSE YOU'LL WANT YOUR FREE SUBSCRIPTION TO THE "CAPACITOR"

All the important radio data of the month, condensed for you. Write now: Cornell-Dubilier Electric Corp., South Plainfield, New Jersey.

NAME _____

ADDRESS _____

CITY _____

STATE _____

ZONE _____

ALL AVAILABLE THROUGH YOUR LOCAL C-D JOBBER

Cornell-Dubilier

WORLD'S LARGEST
MANUFACTURER OF

Capacitors



MICA • DYKANOL • PAPER • ELECTROLYTICS

ADV Plans, LLC

Copyright Notice:

The entire contents of this CD/DVD are copyright 2014 by ADV Plans, LLC. All Rights Reserved.

Reproduction or distribution of this disk, either free or for a fee is strictly prohibited. We actively monitor and remove listings on eBay thru Vero.

You are free to copy or use individual images in your own projects, magazines, brochures or other school projects.

Only the sellers listed here are authorized distributors of this collection:
www.theclassicarchives.com/authorizedsuppliers

Please view our other products at
www.theclassicarchives.com,
or our ebay stores:

[TheClassicArchives](#)
[ADVPlans](#)
[SuperShedPlans](#)

